

Interference Mitigation Approach for WBAN by Improving RAKE Receiver Modulation

Mainak Chakraborty¹, Suparna Biswas²

¹(Department of CSE, MAKAUT, West Bengal India)

²(Department of CSE, MAKAUT, West Bengal India)

Abstract: In Wireless Body Sensor Network in order to diminish the interference caused by interpersonal communication and avoiding packet overhead collision problem in data link layer and MAC layer we propose a rake receiver to be implemented in body sensor network and improving the modulation techniques. Rake receivers are widely accepted because of its efficiency to remove near far problem. Moreover in recent research works encompassing the wireless sensor body area network highlights that body sensor intermediate control nodes are not immune to noise elimination and data reshaping. Most of the data exchanged between these nodes gets lost due to this problem and maintenance cost of the entire network boosts up due to power loss and regeneration. In the proposed Rake receiver architecture the body sensor is allowed to be kept in optimized size balancing the power loss, performance and circuit complexity.

Keywords: WBAN, QPSK, MAC layer, Bit Error Rate, Signal to Noise Ratio

I. Introduction

In the domain of high speed communication, Wireless Body Area Networks(WBAN) are mostly preferred because they consists of small, inexpensive battery powered communication devices accurately deployed throughout human physical space. WBANs promise to revolutionize health monitoring and increase a user's quality of service giving uninterrupted and ubiquitous, ambulatory and wearable health monitoring at the lowest level .Now to achieve optimum performance of WBAN, MAC (Medium Access Control layer is a sub layer of Data Link layer in OSI model) plays a pivotal role. In this following figure it is empirically illustrated the usage of WBAN in ongoing decades.

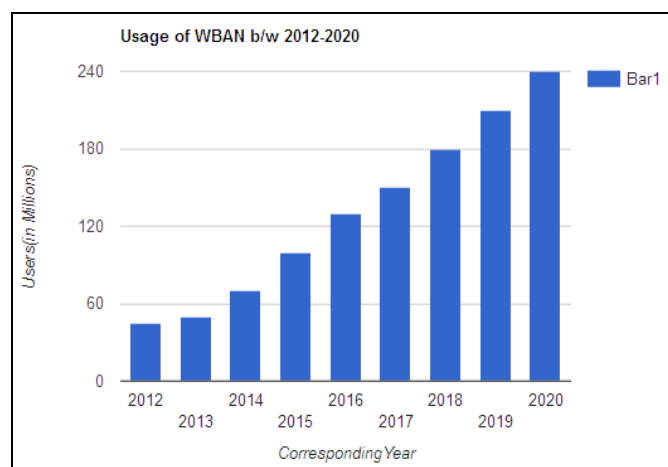

Fig1:- WBAN Market survey [2]

Research trends in WBANs are being done rapidly for different fields of application . In particular, under the channel and physical layer main research themes, there is a lot of SCI journal research papers have been published. The physical layer field has mainly been studied in Belgium Singapore. The application, channel, and cross-layer fields have been studied well in the USA, the UK, and Belgium, respectively.

II. Implementation Mechanism

According to the current market survey [2] from a general understanding of the BAN and the system requirements, it is evident that possible candidates in implementing BAN should be short range communication technologies. IEEE 802.15.1 Bluetooth operates in the 2.4GHz ISM band, from 2400MHz to 2483.5MHz The system employs a frequency-hopping multiple access schemes to combat interference and fading. The symbol rate is 1 M symbol/s supporting a bit rate of 1 Mb/s. For example, ECG signal from each

channel are digitized at 360 Hz with 11-bit resolution implying a data rate of 3.84 Kbps per channel, so all 12 channels of ECG data can potentially be transmitted using Bluetooth. In addition, forward error correction (FEC) and automatic repeat request (ARQ) for retransmission are used as authentication of reception to ensure reliable communication. Based on its suitability of BAN, we test a prototype system for BAN using Bluetooth technology. We will discuss the detailed system later in this paper. By utilizing the ECG compression techniques, we expect to achieve the objective of reducing the amount of digitized ECG data as much as possible while preserving the diagnostic information in the reconstructed signal. The compression ratio (CR) is a measure of the compression performance, defined as the ratio between the number of bits needed to represent the original and the compressed signals.[3]

As the demand of radio spectrum increases in past few years and licensed bands are used inefficiently, improvement in the existing spectrum access policy is expected. Dynamic spectrum access is imagine to resolve the spectrum shortage by allowing unlicensed users to dynamically utilize spectrum holes across the licensed spectrum on non interfering basis. Though in most cases IEEE 802.15.4 use CSMA-based scheme in a contention access period.[8] However, it appears a big challenge as the no guarantee can be provided for channel sensing. cannot be guaranteed in all for all frequency bands and scenarios. UWB system usually the channel sensing is not reliable because SNR is found very low. This findings was aimed towards the detection and classification of primary user’s waveform in Wireless Body Area networks. The primary requirement of a spectrum sensing system is its real time processing and decision making. The proposed methodology has been implemented on waveform considered random in phase.[5]

III. Modulation Techniques

With narrow-band transmission, the carrier can be digitally modulated by switching the signal (on-off keying; OOK), frequency (frequency shift keying; FSK) or phase of the carrier (phase shift keying; PSK). The bandwidth of all three techniques is approximately equal to the signaling rate. Phase shift keying is a widely used modulation format for low bit-rate applications and moderate error performance. Therefore, BPSK and the more complex form QPSK seem to be suitable due to simplicity and low hardware cost. Typically, PSK detection consists of two matched band pass filters tuned to the carrier frequency and the phase shift, respectively, plus a symbol detector and decision circuit.[6] Coherent PSK detection uses synchronous detection for better noise rejection performance but needs to synchronize to the frequency of the sender. An optimal solution focuses on low power consumption and reduced complexity at reasonable data rates. For low-power operation it is important to know the minimum required output power of the transmitter to guarantee signal detection at the receiver input. The output power requirement of the transmitter is therefore determined by following factors:-

- a. noise from the electronic system
- b. noise from the interfacing electrodes
- c. the chosen modulation scheme
- d. the channel attenuation

Noise contribution from the receiver input itself is best described by the input noise figure of the receiver front-end ,or .Where N is the noise, k is Boltzman Constant, T absolute temperature and R is the input circuit resistance. We basically choose QPSK as best suited modulation techniques for Rake receiver because of its finest constellation nature and its notion of adjustment to orthogonality.[1]

For example when data coming from body sensor towards control node is orthogonal QPSK modulated then it will be first equalized and then fed to the rake receiver we observe that the noise appears to be maximum at 0.1 cycles/data. QPSK is equalized because it proves that

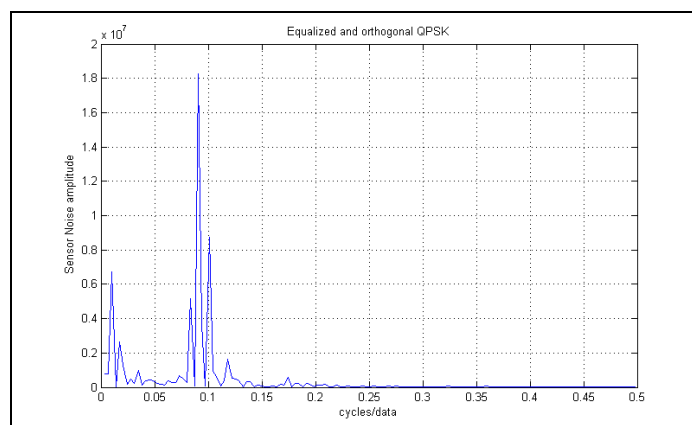

Fig2:- QPSK signal in Equalized and Orthogonal Form

IV. Error Detection And Control For WBAN Data In MAC Layer

However, the clinical acceptability of the reconstructed signal should always be determined through visual inspection by physicians. [2] Existing data compression techniques for ECG signals can be classified into three main categories: Direct data compression methods, transformation methods and parameter extraction methods. Based on the ECG data characteristics and implementation complexity, we choose the following schemes:

1. Split the original signal into M successive blocks, each having N samples.
2. Transform each block using discrete cosine transform (DCT).
3. Quantize of DCT coefficients.
4. Encode the quantized DCT coefficients using LZW coding.

The IEEE 802.15.6 standard provides one Media Access Layer (MAC) and three Physical layers (PHY) containing of Narrowband (NB), Ultra wideband (UWB), and Human Body Communications (HBC) layers. The selection of each Physical layer depends on the application requirements. In vital health monitoring environments, the real-time and reliable applications are required. The monitoring signal is very important for the patient that unacceptable for loss, missing, or even damage, and the UWB layer is suitable for these kinds of application. [1] To mitigate errors of WBAN communications, one can implement error correction at either PHY or MAC, or both layers. Error correction implemented in PHY should be performed at channel coding which can be done before modulation. BCH coding is a binary code and it can identify location of error bit, it is employed at PHY to improve robustness of PLCP header and able to correct up to two erroneous bits. In contrast, the error correction in MAC layer can be performed at a frame level. Recently, there are many researches attend for mitigation of error occurrences, and it is desirable to use a suitable channel code or Forward Error Correction (FEC) [5]. In general, these codes add a systematic redundancy to the transmission packet and allow the receiver to detect a limited number of errors that may occur anywhere in the message, and often to correct these errors without retransmission it is proposed a packet error mitigation technique implemented at PHY layer using Reed Solomon code and compared with Linear Block code. In our analysis we use first BPSK at rake receiver then applied Linear Block Code with least square error correction. The result shown that, the throughput of RS code was higher than LB code, when the error bits less than correctable bits. It is stated that the MAC protocol plays a significant role in many functions especially to control and reduce power by mitigation retransmitting request. To mitigate request of retransmission at PHY channel coding level, shorten version of RS-code (28, k , t) over the channel was examined. In medical video transmission application, it requires high reliability and strong error control, the hybrid ARQ error control in UWB was proposed. However such a system required the retransmission process when errors were detected in time of channel Estimation by Statistical Modeling.

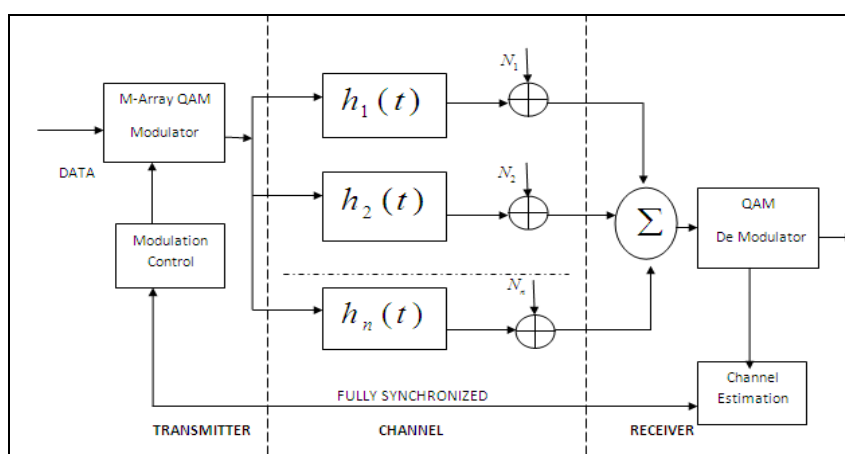

Fig3:- Model of Proposed Rake receiver

In the above shown diagram internal structure of a rake receiver is described. Here modulation is Quadrature Amplitude Modulation. It is basically by means of two separate carriers with 90° phase shift. This QAM is adaptive in nature. Adaptive specifies that it can automatically changes its own properties adjusting any change in communication channel keeping the overall power spectral density same. The mode of adaptation is done by modulation control block which consist of a group of Wiener Filter. Now the basic data signal is directly fed to the channel. Here n number of path has been shown through which data has been transmitted towards receiver. Eventually it gets mixed with Additive White Gaussian Noises. And h represents

corresponding channel path impulse response. Now at the receiver section they are again correlated by the Channel estimation block which is fully synchronized by the modulation control block. Then original data will be recovered.[7]

In this rake receiver designing we first use Walsh Hadamard Transform to discretize the ECG signal and the result is :-

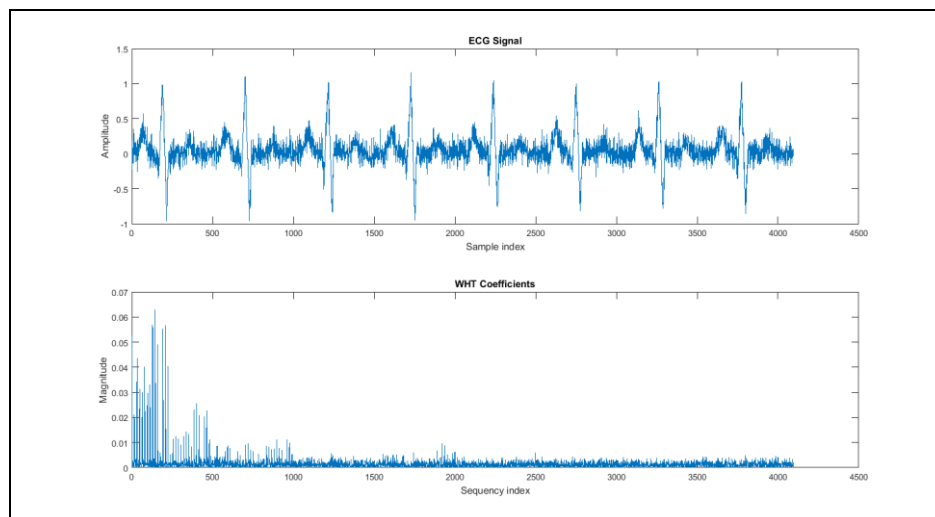

Fig4:- ECG signal and its WHT coefficients

So in our proposed rake receiver it is shown that minimize the channel noise and improve throughput keeping power wastage in least by means of coding and hybrid modulation technique.

V. Mathematical Explanation

In the next section, our system model is introduced. The Bit Error Ratio (BER) performance of Rake-receiver assisted fixed mode QAM employing antenna diversity is analyzed in further section. Accountably, the average BER and the throughput of combined AQAM is expressed in a closed form as a function of the modulation switching thresholds. Finally, the performance of Rake receiver and receiver antenna diversity assisted AQAM employing optimum mode switching levels is presented first, before concluding in continuing. Our Rake-receiver and D-antenna diversity assisted AQAM system is illustrated in Fig. 1. A band-limited equivalent low pass m-array QAM signal $s(t)$, $S(f) = 0$ if $f > 1/2 W$, is transmitted over time variant frequency selective fading channels and received by a set of D RAKE-receivers. Where $S(f)$ is the channel power spectral density and W is the channel bandwidth. Each Rake receiver combines the resolvable multi-path components using Maximal Ratio Combining (MRC). The combined signals of the D number of Rake-receivers seen in Fig. 3 are summed and demodulated using the estimated channel quality information. The estimated signal-to-noise ratio (SNR) is fed back to the transmitter and it is used for deciding upon the highest throughput m-array square QAM modulation mode capable of maintaining the target BER. A K-mode adaptive modulation scheme adjust its transmit mode to mode-k, where $k \in \{0, 1, \dots, K-1\}$, by employing m_k -array modulation according to the estimated SNR perceived at the receiver. The mode selection rule is given by:

Choose mode k, when $S_k \leq \gamma \leq S_{k+1}$,

where a switching level S_k belongs to the set s and $k = 0, 1, \dots, K$. The boundary switching levels are usually given as $S_0 = 0$ and $S_k = k$. The Bit Per Symbol (BPS) throughput

b_k of a modulation mode k is given as $b_k = \log_2 m_k$ if $m_k \neq 0$, otherwise $b_k = 0$. It is convenient to define the incremental bit per second C_k as $c_k = b_k - b_{k-1}$, when $k > 0$ and as $c_0 = b_0$, provided that $k = 0$. In an effort to derive the achievable upper bound performance we assume that the channel quality is estimated perfectly and it is available at the transmitter immediately. The effects of channel estimation error and feedback delay on the performance of AQAM were studied for other cases. Here a 5-mode square-constellation based AQAM scheme has been studied due to the superior BER performance of Gray-mapped square (JAM) constellations in comparison to other m-array techniques. The low-pass equivalent impulse response of the channel between the transmitter and the d-th antenna, $d = 1, 2, \dots, D$, may be represented as

$$h_d(t, \tau) = \sum_{n=1}^N h_{d,n}(t) \delta(\tau - \frac{n}{W}) \dots\dots\dots (5.1)$$

Here τ and t denotes time function of the corresponding n^{th} tap weight of rake receiver
 But if we consider multipath channel delay then the equation becomes:-

$$h_d(t, \tau) = \sum_{n=1}^N h_{d,n}(t) \delta(\tau - \frac{n}{W}) + z_d(t) \dots\dots\dots (5.2)$$

Where $z_d(t)$ is the zero mean Gaussian Noise Distribution with two sided power spectral density $N_0 / 2$. Let us assume that $\Delta t \leq T$ where Δt is the coherence time and T is the signaling period. Then we can simply conclude that for $h_{d,n}(t)$ of signaling period T can be expressed as

$$h_{d,n}(t) = \alpha_{d,n} e^{j\phi_{d,n}} \dots\dots\dots (5.3)$$

Where $\alpha_{d,n}$ is the fading magnitude and it is Rayleigh Distributed and $\phi_{d,n}$ is the phase magnitude it is uniformly distributed. An ideal RAKE receiver combines all the signal powers scattered over N paths in an optimal manner so that the instantaneous Signal-to-Noise Ratio (SNR) per symbol at the RAKE receiver's output can be maximized. The noise at the RAKE receiver's output is known to be Gaussian. The SNR, at the d^{th} ideal RAKE receiver's output is given as :-

$$\gamma_d = \sum_{n=1}^N E / N_0 \alpha_{d,n}^2 \dots\dots\dots (5.4)$$

Where $\alpha_{d,n}$ is perfectly normalized and confirming the relation that $\sum_{n=1}^N \alpha_{d,n}^2$ becomes unity. Now by

means of Inverse Fourier Transform we can recomputed the Probability density function of the channel γ_d and it may take the form as:-

$$f(\gamma) = \sum_{d=1}^D \sum_{n=1}^N K \frac{1}{(d-1)! \gamma_n^d} \gamma^{d-1} e^{-\gamma/\gamma_n} \dots\dots\dots (5.5)$$

So, from this the average BER for our proposed rake receiver can be expressed in the form array square QAM by Gray Mapping as:-

$$P_{e,k} = \int_0^{\infty} P_{m,k}(\gamma) f(\gamma) d\gamma \dots\dots\dots (5.6)$$

Where $P_{m,k}(\gamma)$ is the M array Square QAM employing Gray Mapping over Gaussian Channel

$$P_{m,k}(\gamma) = \sum_i \sum K Q(\sqrt{\alpha_i \gamma}) \text{ Here } K \text{ is the channel adaptive constant} \dots\dots\dots (5.7)$$

The channel model we adopt is the exponential channel model which provides a good compromise between simplicity and reality. The taps are complex, zero mean Gaussian random variables with variances that decay exponentially. The taps can be written as:-

$$h_k = N(0, \frac{1}{2} \sigma_k^2) + jN(0, \frac{1}{2} \sigma_k^2), k = 0, 1, \dots, K_{\max} \dots\dots\dots (5.8)$$

Here obviously,

$$K_{\max} = [10\tau_{rms} / T_s] \dots\dots\dots (5.9)$$

where τ_{rms} is the root mean square delay spread, and T_s is the sampling period which is the space between the taps, is the normalization factor which ensures that the sum of the average power profile is one. Theoretically, there are an infinite number of taps in the exponential model; However, the magnitude of the taps decays rapidly. The normalization plays here a pivotal role because we want to deploy AWGN. Therefore, it is reasonable to truncate the taps at some point which is given by

$$\sigma_k^2 = \sigma_0^2 \beta^k \dots\dots\dots(5.10)$$

Where β is the path loss exponent and σ_0^2 is the normalized channel estimated standard deviation.

Finally we obtain that

$$\sigma_0^2 = \frac{1-\beta}{1-\beta^{k_{max}+1}} \dots\dots\dots(5.11)$$

VI. Output Response of The Proposed Rake Receiver

As we have already aware of the corresponding error probabilities from the Binary Phase Shift Keying that is basically very much converging to zero and its should not be applicable for the cases when number of user is much more. As in our consideration number of patients using WBAN communicate with each other in very small distance. BPSK may be applied with successful adjustment for noise elimination.[7] To meet with this purpose we can deploy Minimum Lest Square Error method of noise adjustment. The corresponding BPSK and MLSE is shown in the following graph. Here we consider that the equalizer is linear in nature and its effective mean is zero. Its corresponding graph is also shown.

Un coded QPSK and BPSK compare:- The code used here is convolution code and results are shown below:-

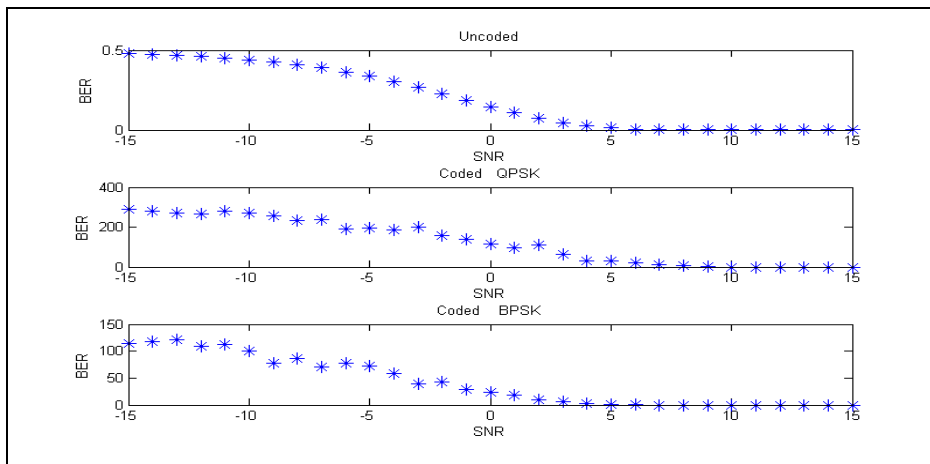

Fig5:- Output Response of body sensor RAKE receiver for QPSK, BPSK and Un-coded sensor data

In the above shown figure it is proved that convolution coded QPSK may be best suited approach for Rake receiver placed in body sensor designing from the point of convergence and noise elimination.

We are obtaining the BPSK and MLSE curves from the Equation (5.3) and (5.4) by changing the value of $\alpha_{d,n}$ and σ_k^2 . For the zero mean equalizer response obtained from equation (5.2) we closely observe that BPSK curve is the most desirable for giving maximum BER.

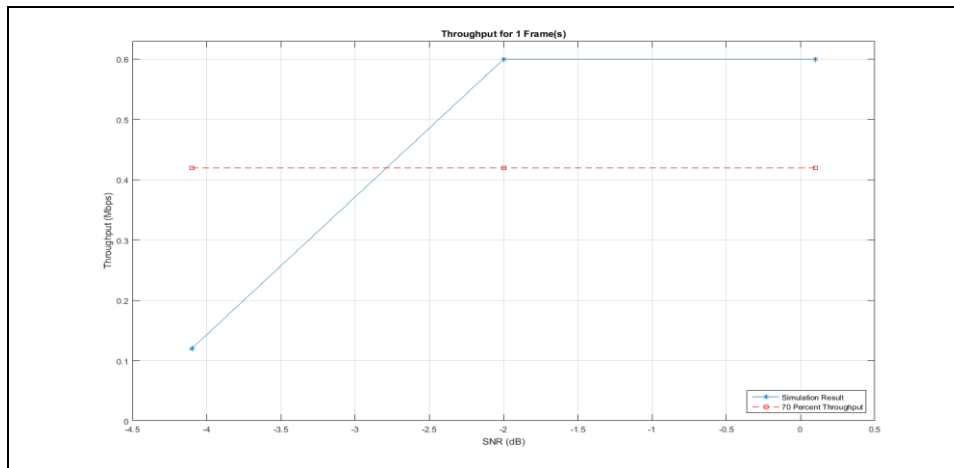

Fig6:- Throughput vs Signal to Noise Ratio

Overall throughput of the proposed rake receiver placed in body sensor we finally obtain from the curve that at -2 dB throughput is maximum (i.e 0.6) using QPSK modulation when a frame of data flow is generated between transmitter and receiver. we ultimately realize that after initial sharp increment it gets almost stable and it is the optimized result as proposed by our channel estimation model.

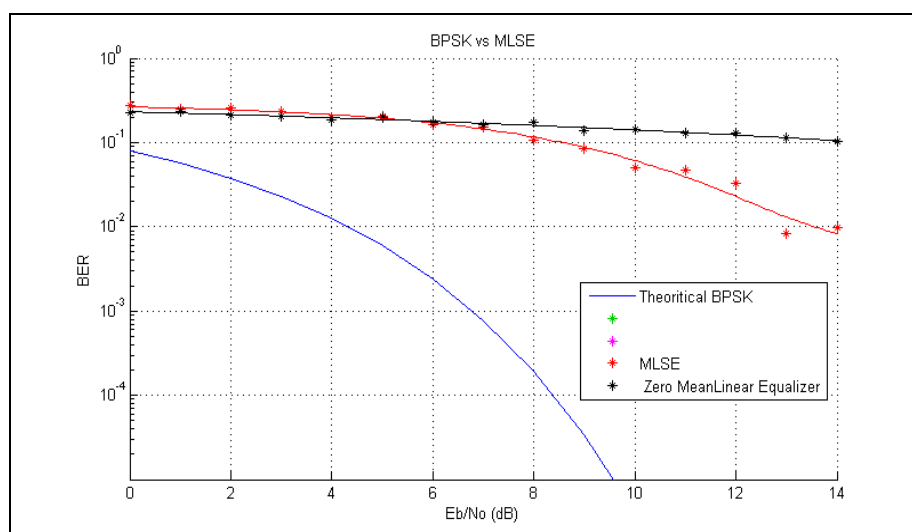

Fig.7. Equalized Output of rake receive compared with Theoretical BPSK and when MLSE error present

In the Fig. 7 Bit Error Rates of our proposed RAKE receiver for three different body sensor signal are plotted against to the energy per bit to noise power spectral density ratio. We modulate the body sensor data first BPSK then Minimum Least Square Error Algorithm is applied and at last zero mean linear equalizer is used for reshaping the data at output end. It is evident that plot of BPSK is converging than other two. So we suggest that in our proposed model BPSK can be applied for perfect balance in BER and E_b/N_0 ratio.

VII. Conclusion

In overall analysis it is observed that using Rake receiver in body sensor we can eradicate the noise caused by channel fading and interpersonal communication. However in networking domain the problem of packet overhead collision can also be minimized by relay repeaters which will perform Hybrid modulation techniques. Only Time Division Multiple Access can not give satisfactory approach because it is not prone to interference mitigation and it increases packet overload. Its lack of synchronization is improved by designing this Rake Receiver. This hybrid modulation is a mixture of both CDMA and TDMA. We propose that these relay repeater's functionality will not confined only data exchange between body sensor node and intermediate control node but also removal of channel fading and reshaping the original medical data of patient and ensuring its security. Further improvement may be done by perfect synchronization as well as normalizing MLSE for the Rake receiver.

References

- [1] Baldonado, M., Chang, C.-C.K., Gravano, L., Paepcke, A.: The Stanford Digital Library Metadata Architecture. *Int. J. Digit. Libr.* 1 (1997) 108–121
- [2] D. Jea and M. B. Srivastava, "A remote medical monitoring and interaction system," *Proceedings of the 4th International Conference on Mobile Systems, Applications, and Services (MobiSys '06)*, Uppsala, Sweden, June 2006.
- [3] Morchon, O.G, Baldus H, Sanchez, D.S, 3-5, "Resource Efficient Security for Medical Body Sensor Networks, Wearable and Implantable Body Sensor Networks", *BSN International Workshop*, 4pp, April 2006.
- [4] N. F. Timmons and W. G. Scanlon, "Analysis of the performance of IEEE 802.15.4 for medical sensor body area networking," in *Proceedings of the First Annual IEEE Communications Society Conference on Sensor and Ad Hoc Communications and Networks (IEEE SECON 2004)*, October 2004, pp. 16–24
- [5] Interference Mitigation Between WBAN Equipped Patients by Judhistir Mahapatro, Sudip Misra, Nabiul Islam, IEEE
- [6] An Error Control Coding in MAC Layer for UWB WBAN by Wannarit Khattiya, Sekson Timakul, Somsak Choomchuay.
- [7] Scalable and Robust Medium Access Control Protocol in Wireless Body Area Networks
- [8] J. Ma, M. Gao, Q. Zhang and L. M. Ni, "Energy-efficient localized topology control algorithms in IEEE 802.15.4-based sensor networks," *IEEE Transactions on Parallel and Distributed Systems*, vol. 18, no. 5, pp. 711-720, May 2007