

Influence of Low-Temperature Plasma Argon on Bacteria

¹Ali A-K. Hussain, ²Hamid H.Murbat, ³Hasan Ali Tawfeeq,

⁴Nisreen Kh.Abdalameer

^{1, 2, 4} University of Baghdad, College of Science, Department of Physics

^{3, 5} University of Baghdad, College of Science for women, Department of Physics

Abstract: Non thermal argon plasma needle at atmospheric pressure was constructed. The experimental set up was based on a simple and low cost electric components that generate electrical field sufficiently high at the electrodes to ionize various gases which flow at atmospheric pressure. A high AC power supply was used with 9.6kV peak to peak and 33kHz frequency. Used the non-thermal plasma argon to two types of Gram-positive bacteria, was fully kill her in a time of 40 seconds.

Key words: Plasma Treatment, low-temperature plasma, plasma needle, plasma medicine.

I. Introduction

The bactericidal effect of gas plasmas is routinely used in sterilizing the surfaces of e.g. medical instruments or biomedical materials [1]. The quality and speed of sterilization, the ability of contact-free treatment and penetration of small cavities make this technique highly attractive for medical in vivo applications. A variety of low-temperature atmospheric plasma sources (LTAPS) has been developed recently, such as the plasma needle [2], plasma pencil [3], dielectric barrier discharge (DBD) devices [4] or the plasma torch [5]. A comparative overview of various devices is given in [6, 7]. LTAPS produce a strong bactericidal effect in a very short time, as has already been shown in various in vitro studies [8]. Bacterial cultures are plasma treated for a given (short) time and then incubated for 1 or 2 days. Since bacteria multiply rapidly, the absence of bacteria in the treated region is a direct measure of the bactericidal effect of LTAP [9].

This is due to promising applications in medical research such as electro surgery [10], tissue engineering [11], surface modification of biocompatible materials [12], and the sterilization of heat sensitive materials and instruments [13].

II. Experimental

1- Plasma jet

Plasma jet consists of a hollow stainless steel pipe 100mm long with inner diameter 1mm and outer diameter 2.7mm inserted inside a Teflon pipe as shown in figure (1). The stainless steel connected to the high voltage power supply. As put between teflon pipe and stainless steel pipe filled with teflon tape.

Under certain conditions an argon plasma jet can be extracted from the downstream tube end since there is no discharge inside the plastic tube. The plasma jet obtained by this method is cold enough to be put in direct contact with human skin without electric shock and can be used for medical treatment and decontamination. All configuration the high voltage power supply generates high voltage of sinusoidal shape of 9.6kV peak to peak and frequency of 33kHz.

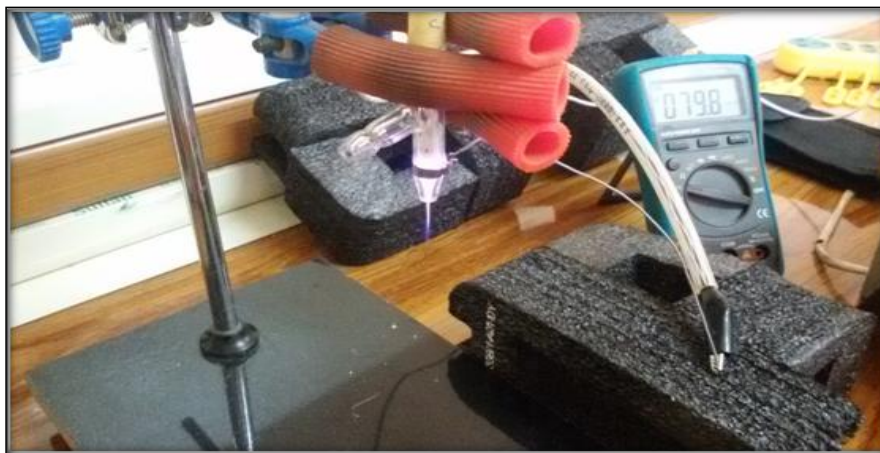

Fig. (1): Plasma torch at working

2- Plasma jet system

Plasma system includes four main parts:

1. The source of alternating high voltages.
2. Plasma jet.
3. Argon gas.
4. Flow meter. Figure (2) shows the schematic diagram of plasma jet the system.

Which consist from high voltage source, plasma torch, Argon gas and gas flow meter.

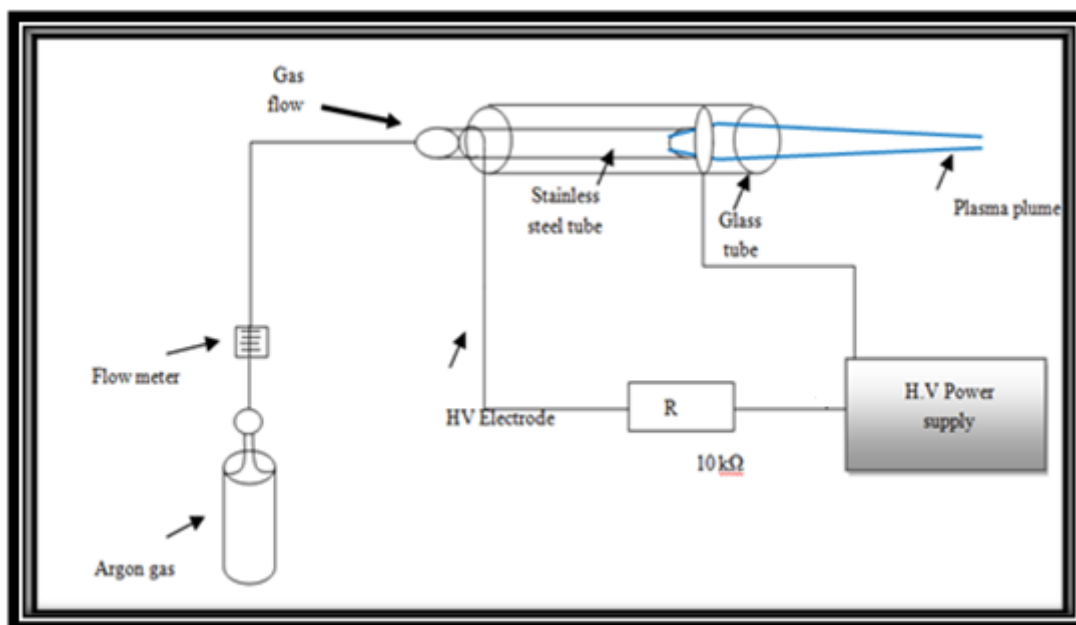

Fig. (2): The plasma jet system

3- Biological application (Bacteria deactivation)

Non thermal plasma jet shown in fig (1), which designed and constricted locally was used to treat different type of bacteria and different strain belonged to different bacteria.

3-1 Sample Preparation

Two bacterial species gram of positive (*Staphylococcus aureus*, *Staphylococcus epidermidis*), from (1 isolates) *Staphylococcus aureus* and *Staphylococcus epidermidis*, were obtained from University of Baghdad - College of Science - Biology department.

Several colonies were picked up from an overnight culture of each isolate, suspended into 10ml of Nutrient broth (N. A.), and then kept for 24 h at 37°C.

3-2 Sample treatment by plasma jet

Bacteria were treated with plasma jet at argon gas flow rate of (1, 2, 3, 4, 5) L/min. The bacterial sample (10µl) was treated by varying time between 10 and 50 seconds. For every treatment set, one types of control were used untreated samples (10µl) inoculum on mannitol salt agar spread the inoculum on the plate by loop. After treatment completed, the plates were incubated at 37°C for 24 h, and bacterial colonies were counted. The effectiveness of the treatment was calculated by two values, the first one calculated by the percentage of C.F.U. and observed on treated plates relative to C.F.U. An untreated plates at the lowest dilution where survival was observed [14].

All experiments were repeated more than once. The efficiency of the antimicrobial treatment is determined by comparing the reduction in bacterial concentration of the treated sample with that of control sample expressed as percentage reduction. Percentage reduction R was calculated using the following formula

$$[15]. R = \frac{N_0 - N_t}{N_0} \times 100\%$$

where:

N_0 = C. F. U. of non treated bacterial (control), N_t = C. F. U. of treated bacteria (t treated time).

The experimental setup used for these treatments is shown in figure (3).

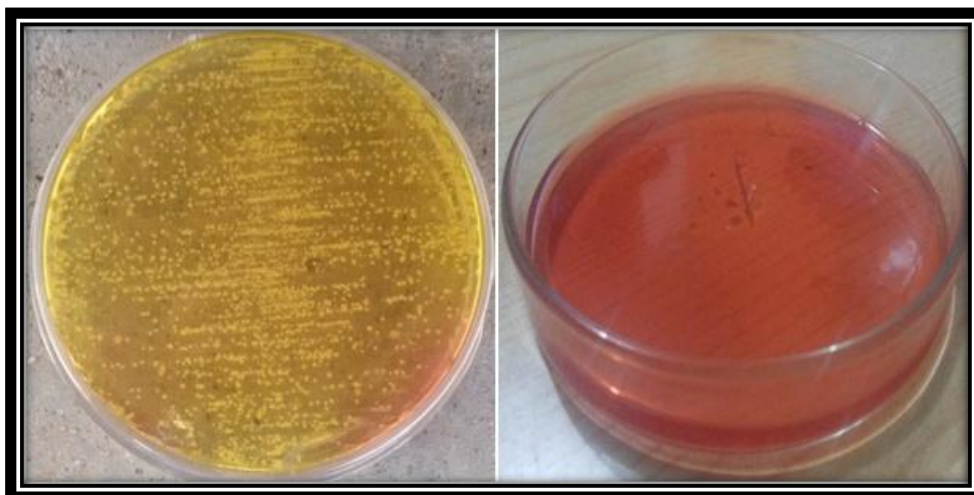

Fig. (3): The image control bacteria

3-3 Sterilization by eradication of bacteria

The sterilization efficacy of plasma jet devices is influenced by gas composition, driving at frequency 15 kHz, and bacterial strain, but plasma jet devices have shown to kill a higher proportion of bacteria than do conventional non-thermal methods such as UV sterilization [16, 17]. The mechanism of plasma sterilization is related to the abundance of plasma components, like Reactive Oxygen Species (ROS), ions and electrons [18].

Also, plasma jet can affect not only the contacted point but also the area around it. Recently, plasma sterilization has been used to treat dental diseases [19]. It was proved that the atmospheric pressure non-thermal air plasma device was effective in killing both *Staphylococcus aureus*, *Staphylococcus epidermidis* [20].

III. Results and Discussion

1-Form of applied voltage

The voltage, waveform is shown in figure (4). The voltage was measured at the ends of the secondary coil of the flyback transformer. From the figure one can see that the voltage have a sinusoidal wave form with frequency of (33kHz). This frequency is near the resonant frequency of the secondary circuit of the flyback transformer which calculated from the RLC values for the secondary coil. The measured voltage at the ends of the secondary coil is (9.6kV) peak to peak.

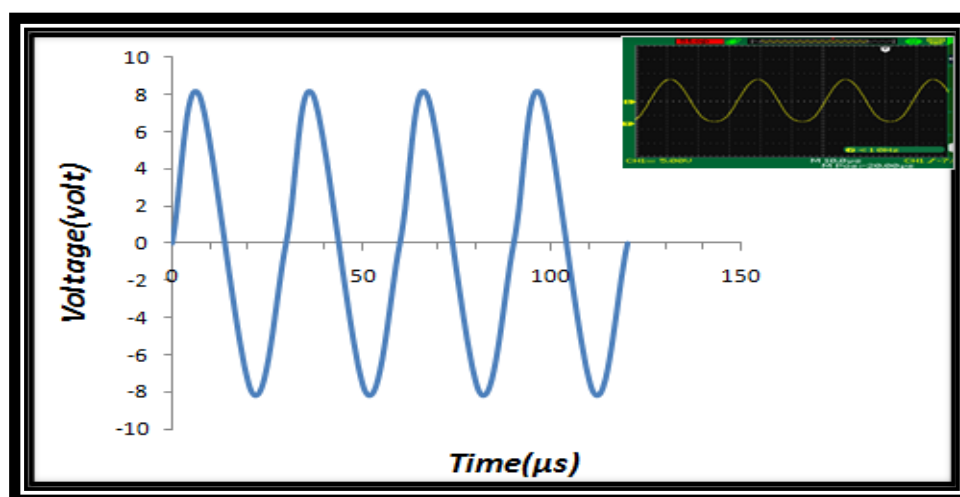

Fig. (4): The waveform of the discharge voltage of the argon plasma jet.

2- Form of discharge current

The current waveform has five damped oscillations of the applied voltage, with $30\mu\text{s}$ cycle as shown in figure (5). This behavior may be due to the capacitive coupling of the circuits with the discharged gas [21]. The current waveform show no spiky lines which indicates that the discharges are homogenous glow also the current leading the voltage, which demonstrates the capacitive character of the discharge [22].

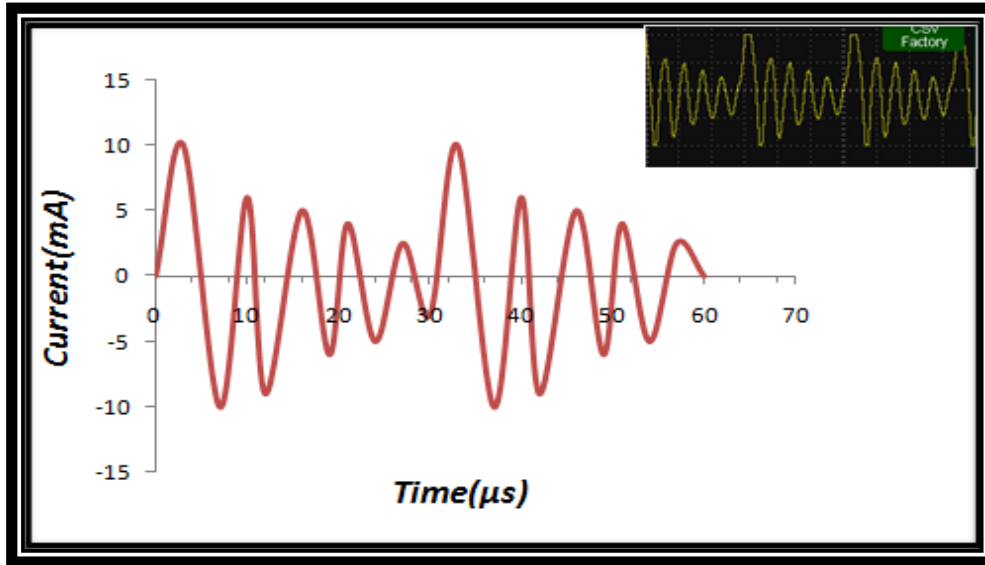

Fig. (5): The waveform of the discharge current pulse of the argon plasma jet.

3-Bacteria deactivation by plasma jet

Optimum conditions was selected Voltage (1750 volt), frequency (15 kHz), distance (2.5cm), time (10, 20, 30, 40, 50) sec, and gas flow rates (1, 2, 3, 4, 5) l/min, by using plasma jet for killing bacteria that inhabit inside the mouth, on the surface of the tongue, and on teeth.

The initial study compared the individual susceptibility of two micro-organisms belonging to different species *Staphylococcus aureus* as shown in Figure (6), and *Staphylococcus epidermidis* as shown in Figure (7).

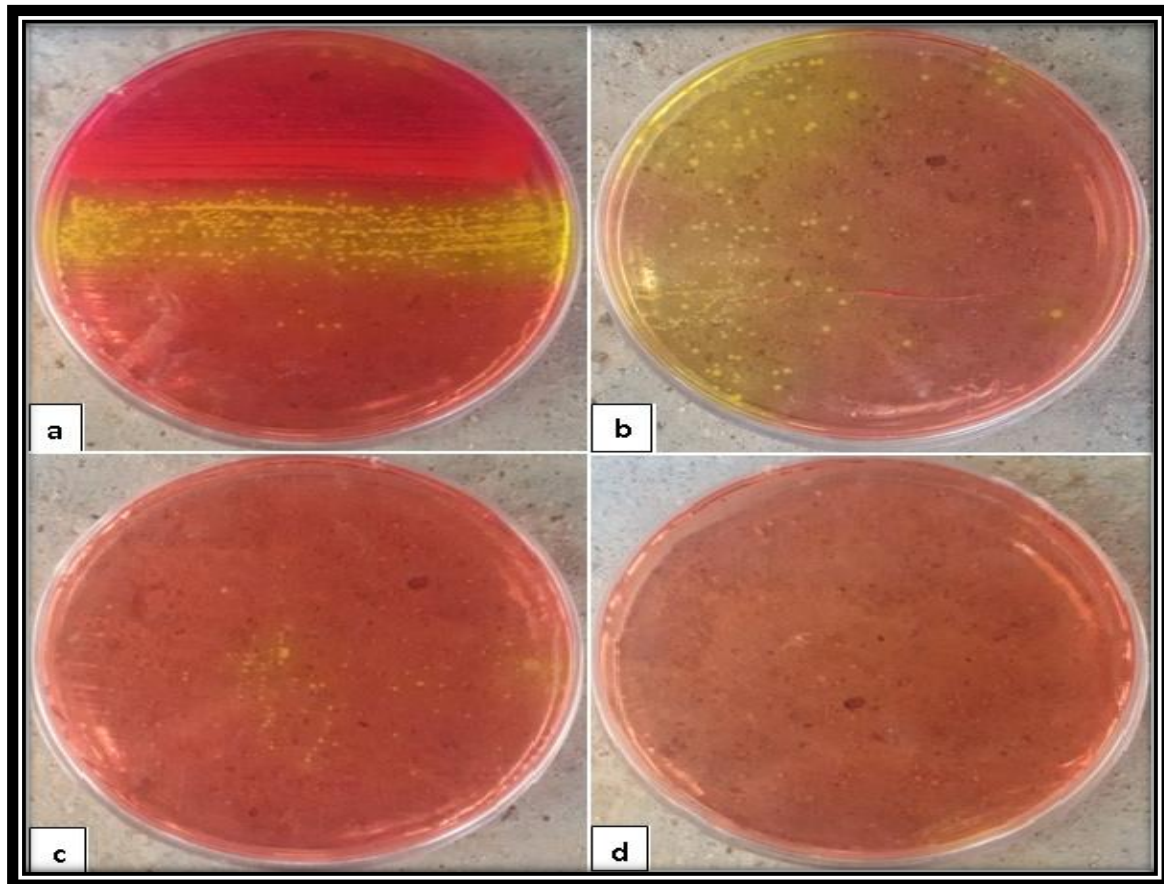

Fig.(6): *Staphylococcus aureus*, a=10sec, b=20sec, c=30sec, d=40sec.

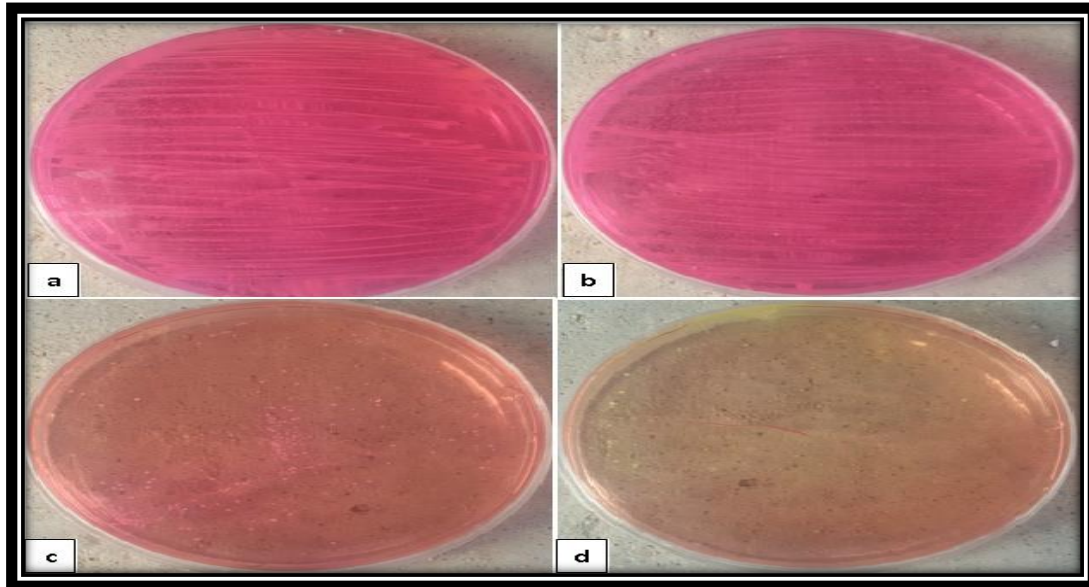

Fig.(7): *Staphylococcus epidermidis*, a=10sec, b=20sec, c=30sec, d=40sec.

Cold plasma produces long living (O_3 , NO , HO_2 , H_2O_2) and short lived (OH , O electronically excited) neutral particles and charged particles (ions and electrons).

All of these could be toxic to cells, induce low levels of cell membrane damage and potentially change intercellular signaling pathways. Specific plasma can be created to produce either neutrals or charged particles in order to elucidate the critical mechanism, charged particles can play a very significant role in the rupture of the outer membrane of bacterial cells [23].

3-1 Study the influence of argon gas flow rate on the bacteria deactivation

Figures (8) & (9) show the relation between the survival percentage for bacteria and the relationship between the Reduction percentage as a function of gas flow rate respectively.

The effects of the increasing gas flow rate and high speed particle discharge penetrating through the outer structure of the bacteria may play a dominant role during the inactivation of the bacteria caused by plasma jet. If bacteria are treated with increase gas flow rate, the cell membrane's structure and electric charges distribution over the cell membrane can be destroyed. In addition with the penetrating effect of the high speed particle discharge the outer structure of bacteria, namely cell wall and cell membrane of culture form, exosporium and coating of the spore, could be destroyed and cytoplasm would be released, which would cause the death of the bacteria. Because the outer structure of the spore was tighter than that of the vegetative form, the vegetative form could be broken by plasma jet and the spore could not be broken but only left with cuts by plasma jet. *Staphylococcus aureus* bacteria more sensitive to the plasma jet treatment than the *Staphylococcus epidermidis* bacteria; at the operating condition that applied in this work, the partial inactivation time for the *Staphylococcus aureus* bacteria greater than *Staphylococcus epidermidis* at time 30s of same conditions [24]. While complete inactivation time for all bacteria at 40s of same conditions.

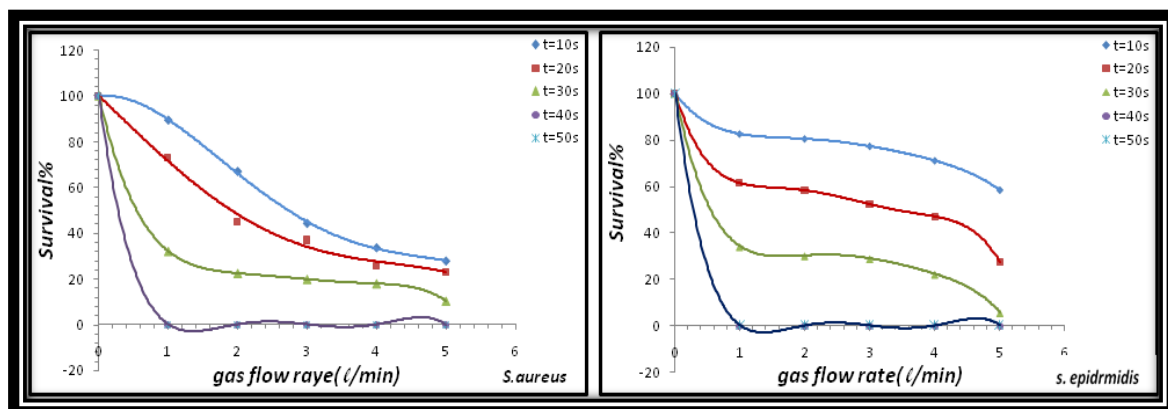

Fig. (8): The relationship between the Survival percentage as a function of gas flow rate.

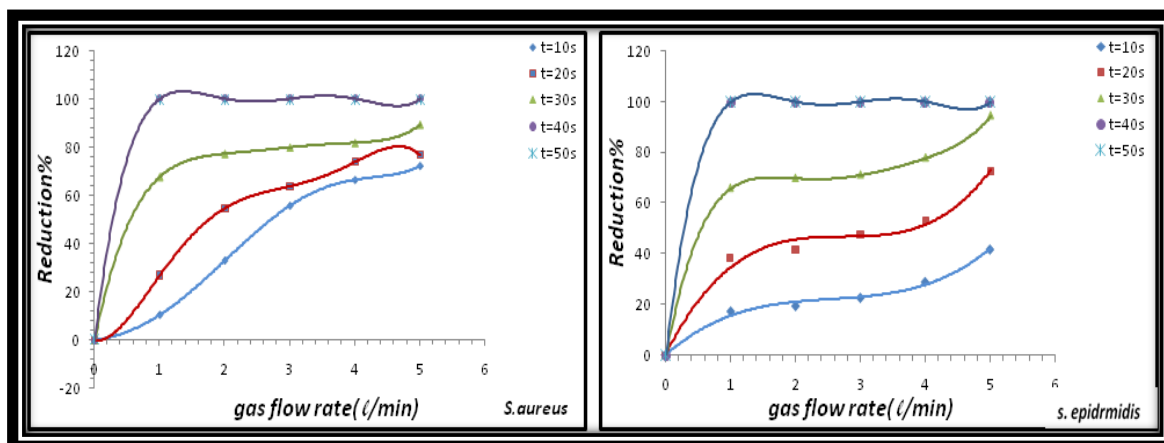

Fig. (9): The relationship between the Reduction percentage as a function of gas flow rate.

From the above results, one can show that:

- * *Staphylococcus aureus* and *Staphylococcus epidermidis* bacteria can be inactivated by exposed to the plasma jet for a period of time. The inactivation increases with treatment time increasing.
- * The inactivation depends on the plasma jet system operating conditions such as applied voltage, gas flow rate and treatment time.

3-2 Study the influence of applied voltage on the bacteria deactivation

In this section, the effects of the plasma jet treatment on *Staphylococcus aureus* and *Staphylococcus epidermidis* bacteria were studied according to conditions. The plasma jet was generated under different applied voltages and times. The bacteria were reduction in different percentages depending on the experiments conditions. The reduction percentage as a function of the plasma jet applied voltages for different conditions was presented in figures (10) & (11). The results, show that the reduction percentage increases with the increasing of treatment time for all applied voltages.

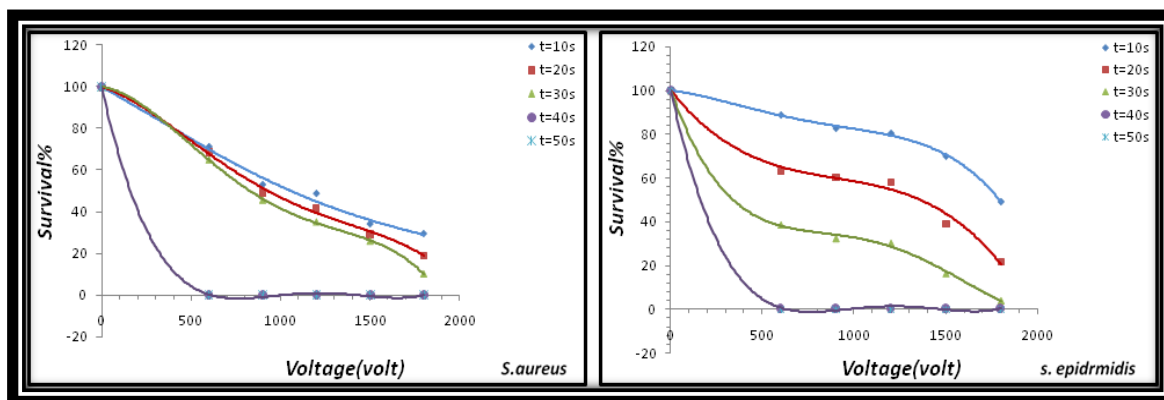

Fig. (10): The relationship between the Survival percentage as a function of Voltage.

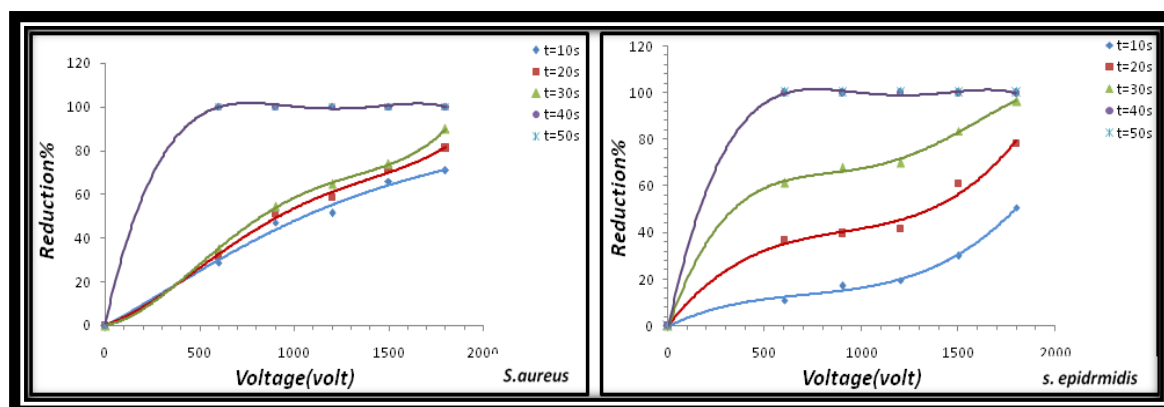

Fig. (11): The relationship between the Reduction percentage as a function of Voltage.

This was because the interaction between bacteria and reaction species was almost complete within 40 sec [25]. This indicate to applied voltage height produced in high degree for gas ionization, hereby increases density various reaction species which was reactive agents to reduction bacteria cells [26, 27].

IV. Conclusions

Plasma needle effective tool used to treat different bacteria types. The 40sec plasma bacteria treatment is sufficient to good killing percent. The temperature of the plasma jet was found to be closer to room temperature than any other plasma jet and the length of plasma jet can be control by varying Argon gas flow rate. In Bacteriological, there was laboratory plasma needle system showed killing percentage effect on Gram-negative and Gram-positive bacteria, charged particles found in plasma can play a very significant role in the rupture of the outer membrane of bacterial cells.

Cold plasma produces long living (O_3 , NO, HO_2 , H_2O_2) and short lived (OH, O electronically excited) neutral particles and charged particles (ions and electrons). All of these could be toxic to cells, induce low levels of cell membrane damage and potentially change intercellular signaling pathways. Specific plasmas can be created to produce either neutrals or charged particles in order to elucidate the critical mechanism, charged particles can play a very significant role in the rupture of the outer membrane of bacterial cells.

References

- [1]. Halfmann H, Bibinov N, Wunderlich J and Awakowicz P 2007 A double inductively coupled plasma for sterilization of medical devices J. Phys. D: Appl. Phys. 40 4145
- [2]. Stoffels E, Flikweert A J, Stoffels W W and Kroesen G M W 2002 Plasma needle: a non-destructive atmospheric plasma source for fine surface treatment of (bio)materials Plasma Sources Sci. Technol. 11 383
- [3]. Laroussi M and Lu X 2005 Room-temperature atmospheric pressure plasma plume for biomedical applications Appl. Phys. Lett. 87 113902
- [4]. Fridman G, Brooks A D, Balasubramanian M, Fridman A, Gutsol A, Vasilets V N, Ayan H and Friedman G 2007 Comparison of direct and indirect effects of non-thermal atmospheric pressure plasma on bacteria Plasma Process. Polym. 4 370
- [5]. Shimizu T et al 2008 Characterization of microwave plasma torch for decontamination Plasma Process. Polym. 5 577
- [6]. Stoffels E 2007 Tissue processing with atmospheric plasmas Contrib. Plasma Phys. 47 40
- [7]. Fridman G, Friedman G, Gutsol A, Shekhter A B, Vasilets V and Fridman A 2008 Appl. Plasma Med. 5 503
- [8]. Pompl R et al 2006 Efficiency and medical compatibility of low-temperature plasma sterilisation Proc. ICRP 6 (Sendai, Japan) p 151
- [9]. Laroussi M 2002 Nonthermal decontamination of biological media by atmospheric-pressure plasmas: review, analysis and prospects IEEE Trans. Plasma Sci. 30 1409
- [10]. K. R. Stalder, G. Nersisyan, and W. G. Graham, "Spatial and temporal variation of repetitive plasma discharges in saline solutions," J. Phys. D, Appl. Phys., vol. 39, no. 16, pp. 3457–3460, Aug. 2006.
- [11]. E. A. Blakely, K. A. Bjornstad, J. E. Galvin, O. R. Monteiro, and I. G. Brown, "Selective neuron growth on ion implanted and plasma deposited surfaces," in Proc. IEEE Int. Conf. Plasma Sci., 2002, p. 253.
- [12]. F. S. Sanchez-Estrada, H. Qiu, and R. B. Timmons, "Molecular tailoring of surfaces via RF pulsed plasma polymerization: Biochemical and other applications," in Proc. IEEE Int. Conf. Plasma Sci., 2002, p. 254.
- [13]. M. Laroussi, "Plasma-based sterilization," in Proc. Int. Conf. Phenom. Ionized Gases, Greifswald, Germany, Jul. 2003, vol. 4, pp. 11–12.
- [14]. S.A. Ermolaeva, A.F. Varfolomeev, Chernukha, M.Y.Yorov, D.S. Vasiliev, M.M, "Bactericidal effects of non thermal argon plasma in vitro", in biofilms and in the animal model of infected wounds.J. Med. Microbiol, Vol. 60, p. 75. (2011).
- [15]. Hamad Raheem H., and Maha Adel Mahmood, "Deactivation of Staphylococcus Aureus and Escherichia Coli using Plasma Needle at Atmospheric Pressure", International Journal of Current Engineering and Technology, Vol.3, No.5, pp. 1848-1851, (2013).
- [16]. Mccullagh C., Robertson J., Bahnemann D.W., and Robertson P., "The Application of TiO2 Photocatalysis for Disinfection of Water Contaminated with Pathogenic Micro-Organisms". A Review Res Chem Intermed, Vol. 33, pp. 359-375, (2007).
- [17]. Kim G.C., Kim G.J., Park S.R., Jeon S.M., and Seo H.J., "Air plasma coupled with antibody-conjugated nanoparticles: a new weapon against cancer". J Phys D: Appl Phys., Vol. 42, pp.305-320, (2009).
- [18]. Louroussi M. "Low Temperature Plasma-Based Sterilization: Overview and State-of-the-Art", Plasma Process Polym., Vol. 2, pp.391-400, (2005).
- [19]. Fridman G., Fridman G., Gutsol A., Shekhter A.B., Vasilets V.N., and Fridman A., "Applied plasma medicine", Plasma Process Polym, Vol. 5, pp. 503-533, (2008).
- [20]. Yang Hong L., Liu S., Hu T., "Application of low-temperature plasma in dental clinical sterilization", Foreign Med Sci Stomatol, Vol. 40, pp. 483-485, (2013).
- [21]. Onyenucheya B., J.Zirnheld, T.Disanto, and D.Muffoletto, "Characterization of non-thermal plasma torch", IEEE, P.1022, (2009).
- [22]. Anghel S., A.Simon, "An alternative source for generating atmospheric pressure non-thermal plasma", Plasma Sources Sci. Technol, Vol. 16, p. B1, (2011).
- [23]. Moisan M., Barbeau J., Crevier M. C., Pelletier J., Philip N., Saoudi B., "Plasma sterilization: Methods and Mechanisms", Pure Applied Chemistry, Vol. 74, pp. 349-358, (2002).
- [24]. Thamer H. Khalaf, Abdul Rahman M.G.Al-Fahdawi, Mohammed Ubaid Hussein, "The role of atmospheric Non-thermal plasma in the bacteria inactivation", Iraqi Journal of physics, Vol. 13, No.26, pp. 92-100, (2015).
- [25]. Yildirim E.D., Ayan H., Vasilets V.N., Fridman G., and Sum W., "Effect of dielectric barrier discharge plasma on the attachment and proliferation of osteoblasts cultured over poly (E-caprolacton) scaffolds", .Plasma process .Polym., Vol. 5, pp. 58-66, (2008).
- [26]. Yu Q S, Huang C, and Hsieh F, Journal of Biomedical Materials Research: Part B, 80, P. 211, (2007).
- [27]. Duan Y X, Huang C, and Yu Q S., IEEE Transactions on Plasma Science, Vol. 33, P. 328, (2005).