

## **A Web-Based DC Prepaid Smart Energy Meter For Solar Irrigation Projects**

**Md. Ilias Rahman, Md. Rabiul Islam, Md. Tarek Hossain And  
Shuvra Prokash Biswas**

*Department of Electrical & Electronic Engineering  
Rajshahi University of Engineering & Technology, Rajshahi-6204, Bangladesh  
Corresponding Author: Md. Ilias Rahman, Md. Rabiul Islam*

---

**Abstract:** *It is becoming obvious that solar irrigation could be an environmentally friendly solution for the agro-based economy of Bangladesh. Since the existing solar irrigation systems use traditional billing systems, it becomes difficult to collect money from farmers which has resulted in extra pressure on the project owners when repaying the soft loan installments. At present, there are two types of meters named ac energy meter and time based energy meter. In case of conventional ac energy meter which is not suitable to handle non sinusoidal input power. Time based energy meter which is easy to develop but not suitable for variable magnitude power sources like solar power. In this paper, a high-voltage (1 kV) dc prepaid smart energy meter is proposed for solar irrigation systems. The proposed smart meter works with dc power, hence the meter can take variable magnitude power as an input. The proposed dc prepaid energy meter also makes solar irrigation system more reliable and acceptable. The proposed model of high voltage dc prepaid energy meter has been implemented with an arduino uno, a global system for mobile communication (GSM) module, radio-frequency identifier (RFID) or smart card sensor, liquid crystal display (LCD) and a relay. In this paper, a prototype 1 kV, 100 A meter is fabricated and tested with real scale solar irrigation system.*

**Keyword:** *Solar irrigation; Smart dc energy meter; GSM; Vending station; System master station.*

---

Date of Submission: 07-10-2019

Date of acceptance: 23-10-2019

---

### **I. Introduction**

Solar photovoltaic is an environmentally friendly option to produce electrical energy, which produces almost free energy once an initial investment is made [1]–[3]. Bangladesh government has already proposed 500 MW solar power systems which are the largest solar power development initiative in Bangladesh. It is estimated that about 3.1% proposed renewable generation will be used for solar irrigation through 1550 pumps of 10 kW each [4]–[10]. The Infrastructure Development Company Ltd (IDCOL) plans to install 1500 solar irrigation pumps across Bangladesh to promote renewable energy programs and to reduce the use of fossil fuels [11]. A smart billing system is necessary to make the solar irrigation system more viable and acceptable [12]. Prepaid billing system is the suitable option to serve this purpose. Prepaid billing provides security of money, helps to pre estimate the energy usage in advance, reduces power loss as the consumers become aware about the balance, removes the complexity of bill production and distribution and also helps to manage load and demand side. For these reasons still prepaid billing is the most popular billing system in the world. The concept of prepaid meter was first introduced in the UK before second world war. Now many developed countries as well as African countries are using prepaid meters [6]–[9]. In Bangladesh, Dhaka Electric Supply Company Limited (DESCO) is producing prepaid meters since 2001, DESCO has set-up a prepaid meters production unit. DESCO already installed prepaid meters in Uttara residential area [8]. Prepaid meters will also be installed in other residential area like Gulshan, Banani, Mirpur and Baridhara. But all these meters are ac prepaid meters and used for households, functioning only for fixed frequency sinusoidal power applications, so it cannot be used in the solar irrigation systems [8]–[10].

Barind Multipurpose Development Authority (BMDA) in Bangladesh is using prepaid billing system for their traditional grid connected irrigation systems. BMDA has installed 4000 sets of prepaid meter on site and implemented a network based on GPRS [12]. This advanced measuring and billing system not only improved efficiency but also offered BMDA programs to search and analysis data. This has resulted in increase in revenue by 15%. Currently BMDA uses time based energy meter for their prepaid billing system [12]–[18]. The time based energy meter is easy to develop but not suitable for variable magnitude power sources like solar power

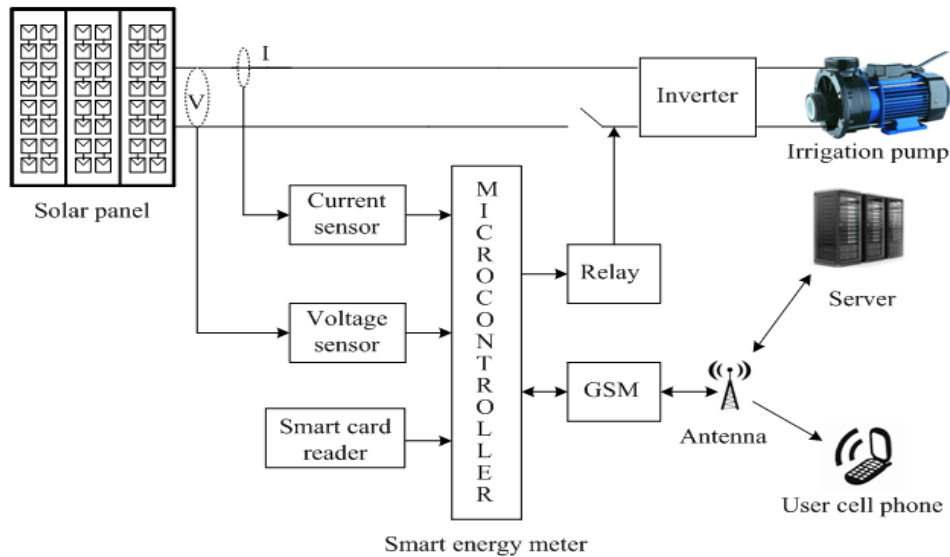

Fig. 1. Proposed energy meter based solar irrigation system.

Therefore, it is necessary to design a dc prepaid energy meter with network prepayment system to install in each water pump house that could implement the prepayment system through IC card meter management. Users would recharge their IC cards and then insert them into the meter to start the water pump [19]. Thus the measuring, billing, water pump operation and data storage would be managed by smart meters. Cloud based software controls the management of all files, multi-tariffs, parameters, and data storage and data analysis. In this paper, a web-based dc prepaid smart meter is proposed and implemented. Since the proposed meter works with dc power, the energy meter can effectively measure energy in solar irrigation systems. Fig. 1 shows the basis block diagram of the proposed energy meter. The use of smart card and global system for mobile communication (GSM) technology would make the energy meter more efficient and reliable for both users and solar power development organizations [20]. The dc prepaid meter with multi-user option is the most suitable technology for the prepaid billing system for solar irrigation. Recharging will be through keypad, web link and cloud based programming software.

## II. Development of The Proposed Energy Meter

### A. Architecture of the Proposed Meter Based Prepaid System

The proposed multi-user prepaid dc solar energy meter will be installed in each pump house. For a specific region there will be a vending station, also called cash dispensing unit (CDU) from where the farmer will purchase credit or recharge their accounts. The vending stations hold the regional user database and billing software. The communication between the dc solar energy meter and the vending station will be done by the use of a smart card. All vending stations are connected with a central server called the system master station (SMS) through the internet.

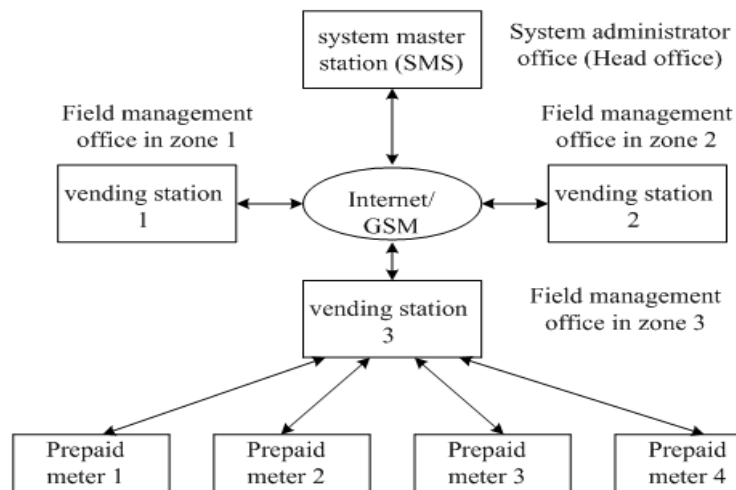

Fig. 2. Architecture of the proposed energy meter based prepaid system.

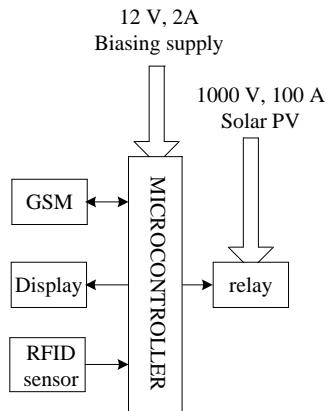

Fig. 3. Architecture of the proposed energy meter based pre-paid system.

The system master station holds the integrated data base of all the vending stations, user account creation software and overall system analysis tools. Fig. 2 shows the architecture of the proposed energy meter based prepaid system.

### B. Smart Energy Meter

The proposed energy meter contains a microcontroller, a GSM module, radio-frequency identifier (RFID) or smart card sensor, liquid crystal display (LCD) and a relay to connect or disconnect the power line. The proposed 1 kV, 100 A rated meter works on a very smart way. Fig. 3 shows the interconnection of microcontroller with different sensors, display units, GSM module, and relay. At first user must recharge his account either from a recharge point or by log in to his account online. Then a user can use his RFID card to get access to the meter. If it is valid, user can see the account balance and pick hour and off-pick hour tariffs. Then user can start his power line connection if he presses the start button located on the energy meter. User must have sufficient balance in his account. Fig. 4 shows flowchart of the programming.

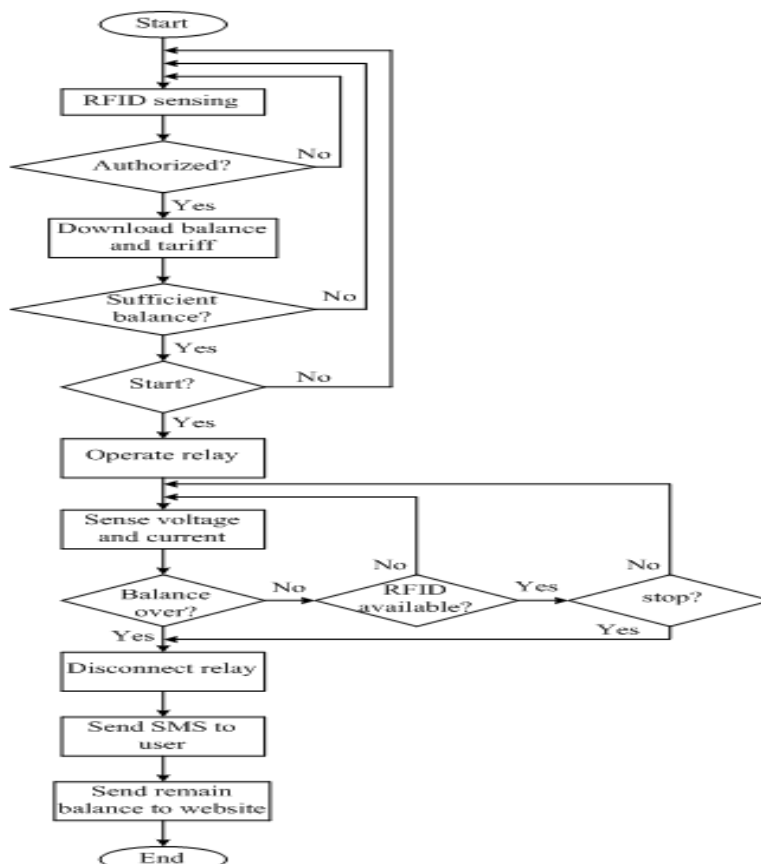

Fig. 4. Flowchart of the proposed energy meter.

The website stores all the information like balance, pick hour tariff, off-pick hour tariff, personal information of the users and many more. When balance is over power line will be automatically disconnected and information like remaining balance and power consumption will be sent to the website using the hypertext transfer protocol (*HTTP*) connection as well as to the user through *short message service* (*SMS*). A user can disconnect the power line by his smart card. To do this he has to press the stop button on the meter after getting access. The full working procedure is shown in Fig. 4.

### III. Implimentation

#### A. Equipments Used

For the implementation of the proposed design major equipments, e.g. arduinouno, LCD display (20×4), SIM900A GSM module, RFID sensor, 1 channel 5 V relay, voltage sensor (20 V), current sensor (ACS 758,100A) are used. Fig. 5 shows interconnection of different modules and sensors.

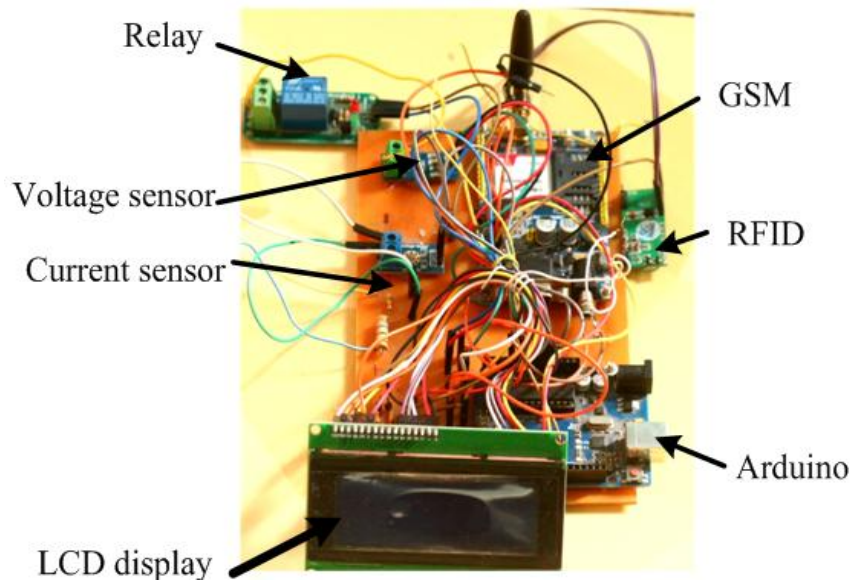

Fig. 5. Connection of different modules and relays.

The arduinouno is used as the processor of the whole system. Arduino is open source computer hardware and software company, project and user community that designs and manufactures microcontroller-based kits for building digital devices and interactive objects that can sense and control objects in the physical world. LCD display shows all the operations. RFID sensor senses the user's smart cards.

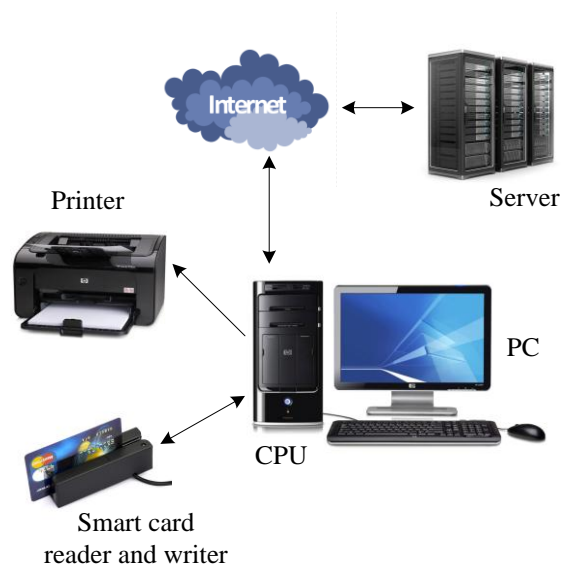

Fig. 6. Recharging system through keypad, web link and cloud based programming software.

The relay is used to on/off the power connection. A single channel 5 V relay is used in this prototype. SIM900A GSM module communicates with the website using HTTP connection and sends SMS to the user according to necessary operations. ACS 758, a fully integrated, Hall Effect-based linear current sensor IC with 100 A current rating and the voltage sensor of rating 20 V is used to measure the voltage from the voltage divider circuit. It isolates the meter circuit from the power line.

### **B. Cloud Based Software**

AT commands are used to program the GSM module to interface microcontroller with the server as well as the user's cell phones. The processor (Arduino) is programmed with arduino commands using arduino 1.6.3 software. The RFID sensor is also interfaced with the processor using arduino commands. The vending station is the office (field management office) where the clients purchase credit and holds the database of all local users. Each pump house has one multi-user prepaid dc solar energy meter and every user will have separate smartcards, which will establish the connectivity between the meter and the vending station. The basic components of the vending station include server PC, smartcard reader/writer and slip printers to print receipts. To keep the database of the vending station up-to-date, clients will be advised to scan the smart card in the meter before coming to the vending station. When the card is scanned, the meter's last status will be copied to the smart card. In the vending station, the last status of the meter from the smart card will be saved in the database. The vending station will upload all the meter statuses to the system master station and download the latest meter settings from the system master station. The smart card reader/writer is interfaced using the serial three wire bus protocol with the CPU to read/write data to smart card. System master station holds the integrated database of all the vending stations. Creating, editing and deleting user accounts will also be performed from here. Fig. 6 shows the recharging system through keypad, web link and cloud based programming software. The prototype 1 kV 100 A dc pre-paid smart energy meter has been fabricated in a compact and shelled casing for its outdoor applications. Fig. 7 shows a photograph of the developed web-based smart pre-paid energy meter for solar irrigation projects.



**Fig. 7.** Prototype 1 kV 100 A dc pre-paid smart energy meter.

## **IV. Results and discussion**

The performance of the prototype meter is verified with a solar irrigation project installed by BMDA in Godagari, Rajshahi, Bangladesh. The project has integrated solar module of 720 V. For the analysis of experimental results, a laptop and an oscilloscope are used. Laptop is used to show the operations of the website and an oscilloscope is used to measure and compare the results. Fig. 8 shows the testing environment of the prototype meter with the solar irrigation project at Godagari, Rajshahi.



**Fig. 8.** Testing of the prototype meter with a solar irrigation project at Godagari, Rajshahi.

Account balance has been checked before connecting the power from the website. Authorized user with valid smart card have access the data on the LCD screen. Fig. 9 shows a scan short of customer account information on the web. When the balance is enough it waits for the permission of the user to start the power connection.

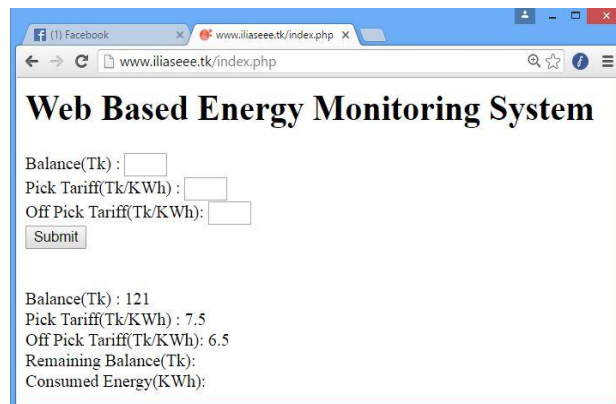

**Fig. 9.** Information on the website.

After the power line is connected current and voltage are measured. As the current sensor is of high rating, the error during low current measurement is little bit high. The voltage is measured from the voltage divider circuit by a voltage sensor which acts as an isolator. If the account balance of the user gets zero the meter automatically stops and sends the information like consumed energy, balance to the account of the user and saves in the server. A text message is also sent to the user cell phone with the information. Fig. 10 shows a photograph of mobile message. Same messaging also available if the user intentionally stops the pump.

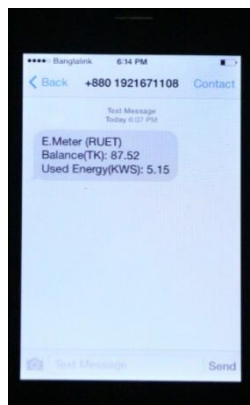

**Fig. 10.** A photograph of mobile message.

## V. Conclusions

Solar pumping inverters have a voltage window of generally 400–850V dc. This high voltage dc prepaid meter is not available in the market. A web-based pre-paid dc 1 kV 100 A smart energy meter has been designed and implemented for solar irrigation project. The proposed meter gives a number of facilities, e.g. money collection from farmer becomes easier, reduction of water wastage, increase in land coverage, revenue expected to increase 20–30%, creates data storage and data analysis facility, and oversee whole management via web link. The investment return is approximately one year. With the increase in number of projects, the investment return will be reduced as each additional project needs only one meter and works under same data management system. It is expected that the proposed smart dc energy meter can be used in solar irrigation systems effectively.

## References

- [1]. M. R. Islam, M. R. Islam, and M. R. A. Beg, "Renewable energy resources and technologies practice in Bangladesh," *Renew. Sustain. Energy Reviews*, vol. 12, no. 2, pp. 299–343, Feb. 2008.
- [2]. M. R. Islam, A. M. M. Rahman, M. M. Islam, Y. G. Guo, and J. G. Zhu, "A modular medium voltage grid connected converter with improved switching techniques for solar photovoltaic systems," *IEEE Trans. Ind. Electron.*, Sept. 2017, DOI: 10.1109/TIE.2017.2652402.
- [3]. M. R. Islam, Y. G. Guo, and J. G. Zhu, "A high-frequency link multilevel cascaded medium-voltage converter for direct grid integration of renewable energy systems," *IEEE Trans. Power Electron.*, vol. 29, no. 8, pp. 4167–4182, Aug. 2014.
- [4]. M. R. Islam, P. C. Sarker and S. K. Ghosh "Prospect and advancement of solar irrigation in Bangladesh: A review," *Renew. Sustain. Energy Reviews*, vol. 77, pp. 406–422, Sept. 2017.
- [5]. Barind Multipurpose Development Authority (BMDA), Pre-paid Metter-Innovation. [Online] Available at: <http://www.bmda.gov.bd>, (accessed on 15/06/2017).
- [6]. Institute of Fuel Research and Development (IFRD). Annual report 2002–2003. Bangladesh Science and Industrial Research (BCSIR), Dhaka, Bangladesh
- [7]. World Bank. Market assessment survey of solar PV application in Bangladesh. Final report, Dhaka, Bangladesh, July 1998.
- [8]. World Bank. Feasibility study for a solar home systems project within the context of alternative options for rural electrification. Final report, Dhaka, Bangladesh, 2000.
- [9]. Ministry of Non-conventional Energy Sources (MNES). Annual report 1996–97, Government of India.
- [10]. Mathur, A. Commercialization of solar energy technologies in India: approaches and challenges. In: Paper presented at the seminar on financing and commercialization of solar energy activities in South and SouthEast Asia, Kunming, China, 26–30 August 1996.
- [11]. Yan L, Kong L. The present status and future development of renewable energy in China. In: Proceedings of high-level expert meeting on solar energy in East and South-East Asia, Akita, Japan, July 1996. p. 133–38.
- [12]. Rural Electrification Board (REB) website: <http://www.bangladeshgov.org/reb/index.htm> [13] Center for Mass Education in Science (CMES) website: <http://www.cmes-bd.org>
- [13]. Global Environment Facility (GEF). Project document of solar and wind energy resource assessment (SWERA), May 2001.
- [14]. Salequzzaman M, Newman P, Ellery M, Corry B. Prospects of electricity in coastal region of Bangladesh: tidal power as a case study. *J Bangladesh Stud* 2000;2.
- [15]. REFOCUS March 2001. ARTICLE IN PRESS 342 M. Rofiqul Islam et al. / *Renewable and Sustainable Energy Reviews* 12 (2008) 299–343
- [16]. Islam MN. Energy policy and energy development strategies for Bangladesh. In: Proceedings of seminar on the role of renewable and alternative energy sources for national development (SRRAESND 2003), KUET, Khulna, Bangladesh, 19–20 December 2003. p. 1–16.
- [17]. [18] Sarker MAR, Ehsan M, Islam MA. Issues relating to energy conservation and renewable energy in Bangladesh. *Energy Sustain Develop* 2003;VII:77–87. [30] Bangladesh Power Development Board (BPDB). BPDB Annual report 2003–2004, Dhaka, Bangladesh
- [18]. Bangladesh Bureau of Statistics. Statistical year book of Bangladesh-2004. Dhaka: Ministry of Planning, Government of People's Republic of Bangladesh; December 2005.
- [19]. Government of Bangladesh (GOB). Bangladesh economic review, 2004.
- [20]. Islam MN. Energy security issues of Bangladesh. *Engineering News*, Institute of Engineers Bangladesh, 2000.
- [21]. Bangladesh Power Development Board (BPDB) website: <http://www.bpdb.gov.bd>

IOSR Journal of Electrical and Electronics Engineering (IOSR-JEEE) is UGC approved Journal with SI. No. 4198, Journal no. 45125.

Md. Ilias Rahman. " A Web-Based DC Prepaid Smart Energy Meter For Solar Irrigation Projects." *IOSR Journal of Electrical and Electronics Engineering (IOSR-JEEE)* 14.5 (2019): 17-23.