

Design of a Pelton Turbine using SOLIDWORKS for Ocean Wave Energy Harvesting in MATLAB Simulink

Muhibul Haque Bhuyan^{1,*}, Md. Sazzad Hossain¹ and Md. Ariful Islam¹

¹Department of Electrical and Electronic Engineering, Southeast University, Dhaka, Bangladesh

Abstract:

This article discusses in detail the design and simulation of a Pelton turbine-based ocean wave energy harvesting system. Before that, the quest for renewable energy resources and in this context, the existing ocean wave energy harvesting devices and systems studied from the literature are described in brief. After that, the Pelton turbine's working principle is also explained with a schematic diagram. The Pelton turbine was designed using SOLIDWORKS, which is a 3D engineering design and product development tool. After that, a MATLAB Simulink model was developed for the energy harvesting process. We simulated the model in the Simulink environment, and simulation results are demonstrated through some graphs. We obtained the maximum and minimum voltages of +440 V and -440 V respectively, a peak to peak current of 340 A, a maximum output electrical power of 3.7 MW, and a maximum speed of 3200 rpm with a constant field voltage of 11.5 V.

Keywords: Pelton Turbine, Ocean Wave, Energy Harvesting, Solid Works, MATLAB, Simulink.

Date of Submission: 28-04-2021

Date of Acceptance: 12-05-2021

I. Introduction

Electrical energy is an essential part of our life in this modern society. This energy is being generated from several types of sources, like wood, coal, gas, oil, nuclear fuel, wind, water, sun, biofuel and waste, geothermal, solar-thermal, etc. Despondently, we generate most of the electrical power by burning wood, coal, gas, oil, etc. [1]. In the world, approximately 80% of the gross primary sources for electrical energy generation are based on fossil fuels. The International Energy Agency (IEA) forecasts that this would remain the same till 2030 with an anticipated annual rise in energy demand by 1.6% in the world [2]. Because, the world's population is growing very rapidly and the living standards are becoming high and as such, electrical energy demands are also rising drastically. This has fetched enormous challenges to our modern society to meet and maintain these growing needs [2]. By using fossil fuels, we are damaging our ecosystem due to carbon dioxide (CO₂) emissions. As a result, we are observing the reduction of forest lands, natural calamities, greenhouse effect, and meteorological changes in most parts of the world [3]. To alleviate these challenges, more efforts and focuses must be made on harnessing clean energy from various renewable energy resources, and also at the same time, attention must be given to shrinking the available energy for consumption by using energy-efficient devices and appliances [4-5]. In this context, the researchers are trying to introduce several suitable and rational approaches to produce clean electrical power from renewable resources at an affordable cost for the last few decades. For example, in Germany, according to [6], the number of wind turbine-based power plants has grown by 227% between 2008 and 2016. Besides, many initiatives have been taken to build energy-saving devices and apparatuses by maintaining the same level of services while taking less amount of energy. The devices and apparatuses that consume the highest amount of energy are the room heaters, air conditioners, water pumps, washing machines, refrigerators, etc. and this constitutes around 40% of the total absorbed energy in household purposes [5].

The world is facing the problems of environmental pollution and depletion of forest lands due to the use of fossil fuels. Besides, these energy sources are being diminished in terms of their supply. As such, engineers and scientists are in quest of substitute resources of energy that are sustainable and environmentally friendly. The road to sustainable clean energy resources is, however, both a long and difficult task. As per Goal # 7 of the United Nations Sustainable Development Goal (SDG), the quest for clean and green energy resources is a must and simultaneously to reduce the use of fossil fuels. However, appropriate renewable energy technologies must be developed and implemented to change the traditional energy resources so that it is economical and sustainable [7].

There are many sources of renewable energy. Of them, ocean wave is a great source of getting electrical power. It is estimated that the ocean wave power may be of the order of 1 TW [8]. We all know that the ocean occupies 70% of the Earth's surface. Ocean wave energy can be a major renewable energy source to get electrical energy [9]. It is steadily becoming an essential alternative electrical energy resource due to its

massive but unexploited prospects [10]. Therefore, if ocean wave energy can be harvested properly then we will be able to produce a huge amount of green electrical power and as such we can meet our electrical energy demand around the globe. It is estimated that the electrical power of approximately 8,000-80,000 TW may be harvested from the ocean wave energy each year [10]. The International Energy Agency (IEA) has predicted that ocean wave energy could ultimately supply more than 10% of the present electrical energy demand on the earth [11].

Ocean Wave Energy Harvesting (OWEH) is defined as widespread engineering technologies that are utilized to acquire electrical energy from the ocean waves employing wide varieties of transformation methodologies and types of machinery. OWEH systems convert the kinetic and potential energy of the natural alternations of ocean waves into electrical energy. There are a variety of appliances for such conversion [12]. The first patent for wave energy to electrical power conversion device was traced in the 19th century. In 1966, the French built a tidal barrage-based power station of 240 MW at La Rance River with an electrical energy generation capacity of 600 GWh per year, and it is functioning till the present [13]. The researchers have estimated that this technique may be a supply of a huge amount of electrical energy on earth, especially to those countries that are located close to the sea line. However, the first commercial unit that went into operation came in 2008 based on floating wind turbines with tidal, wave, and thermal energy converters [14]. It was reported that the theoretically possible prospective electrical energy from numerous kinds of OWEH technique is between 20,000 and 92,000 TWh annually and the world consumes electricity of approximately 16,000 TWh in one year. However, till now it is not conceivable that using only this technique, the total electrical energy requirements of the earth will become possible to meet [15].

In this paper, we report the design of a Pelton turbine-based Ocean Wave Energy Harvesting (OWEH) system using SOLIDWORKS and a wave energy conversion process using MATLAB Simulink. The paper has been organized as follows-

Section II reviews the literature, section III describes the Pelton turbine design process in SOLIDWORKS, section IV explains how energy contained in the ocean wave is converted to the electrical energy using MATLAB Simulink, section V demonstrates the simulation results, and finally, section V rounded off the paper with some concluding remarks and suggestions for future works.

II. Literature Review

Various types of ocean wave energy capturing mechanisms were studied and analyzed in the past. At present, most of the technological innovations, aimed at exploiting ocean wave energy resources, are in their early stages, with only a few went into commercial operation. None of them could operate by using the orbital motion of water particles right below the ocean surface. A kind of sea spoon device could catch the kinetic energy of ocean waves with encouraging conversion efficiency [13].

A prototype wave tank was built to test the output power of a newly designed and implemented OWEH device. A simulation was done for the deepwater waves, and the prototype model, which is also a space-efficient model, generated around 10 mW of power. It was predicted based on Froude scaling ratios that if this prototype model could be scaled up then this model would harvest around 254 W/ft of ocean wavefront [14].

Another experimental work of ocean wave energy conversion was performed based on a 1:20 scaled prototype model of the Inertial Sea Wave Energy Converter (ISWEC) with the mooring layout. They designed and examined the converter for two mooring configurations based on sub-surface buoys with or without clump weights. Tests were done in regular, irregular, and extreme waves for the prototype moored model. They identified a mooring solution that could ensure precise operation in extreme sea environments [15].

Another experimental and numerical performance comparison between two self-reacting point absorber wave energy converter designs was done. All experimental tests were performed on a 1:25 scaled-down prototype model. The authors have explained the design methodology of their model, test and analysis procedures, etc. They also proposed to scale up their prototype design for high power application based on Budal's theoretical upper bound model so that this model might be applied to a self-reacting point absorber method. The design consequences of a reactive power take-off control scheme and relative motion constraints on such conversion method were explored based on the experimentally verified dynamic mathematical model [16].

One method to harness ocean wave energy is to bend or directs the ocean waves by increasing their height into a narrow concentrated channel towards the circumscription of the reservoir to raise the converted power level. Thus the researchers could upsurge the potential energy obtainable for the hydraulic turbine with lower heads [17].

Another most researched Ocean Wave Energy Converter (OWEC) technology is the Oscillating Water Column (OWC) technology due to its robustness, simplicity, and versatility. But the OWC is not used widely concerning application areas and operating methods. Based on the existing OWEH technologies, it is essential to

ascertain the low-cost system of energy conversion systems and synergies or any such unified structures [18-19].

The emphasis is also directed to the Multi-Oscillating Water Columns (M-OWCs) based OWEH system. It has the prominent prospects to escalate the capture on a greater scale, especially in synergy applications. However, wave energy harvesting technologies must be competitive, inexpensive, sustainable, and feasible in the renewable energy amalgam. It is encouraging that the trend of expansion of this technology is moving in the right direction to shrink the Levelized Cost of Energy (LCOE). If the researchers can continue their efforts in this direction then they will be able to make the OWEH system technologies an economical and resourceful option in the renewable energy sector, and thus this technology will get a competitive edge [18, 20-21].

Theoretical estimation of the power generation from the ocean wave generation wave was conducted by considering their performance test in the laboratory with ocean wave parameters. The test results reveal that it is possible to supply the electricity to meet the domestic, industrial, and agricultural needs in the locality by maintaining the established standards [22].

In another paper, the authors discussed two devices- the buoyant moored device and the overtopping system to generate electricity from the ocean wave energy by combining these two. They also discussed the design, assembly, operation, and performance calculation of both these devices/systems. The buoyant moored device uses the rise and falls of the swells to drive the pumps and thus convert ocean wave's mechanical energy into electrical energy. An overtopping system uses the pumped fluid to fill the reservoir at an upper level than the neighboring ocean surface and the potential energy in the reservoir is taken by the low head turbines which generate the electrical power [23].

According to the report of the International Renewable Energy Agency (IRENA), wave energy converters collect mechanical energy from the ocean waves and transform it into electrical energy. There are three core types of such energy-converting devices/systems, such as Oscillating Water Columns (OWC), Oscillating Body Converters (OBC), and Overtopping Converters (OTC). The OWC uses the trapped air pockets in the water column to drive a water turbine. The OBC uses the wave motion in any direction (up/down, forward/backward, side to side) in the floating or submerged devices to produce electricity. The OTC uses the reservoirs to create a head and then drive water turbines. However, each type can be divided in terms of the techniques utilized to transform the wave energy into pneumatic energy through the rotational or translational motion; the prime movers of the system, such as air turbines, hydraulic turbines, hydraulic engines, etc.; type of the structures used, like fixed, floating, submerged, etc.; and their position in the ocean, viz. shoreline, nearshore, offshore, etc. [12, 24]

The estimated Levelized Cost of Electricity (LCOE) of wave energy technologies for a 10 MW project was found approximately EUR330-630 for one MWh of electrical energy generation. The projected LCOE for wave energy in 2030 was estimated to around EUR113-226 for one MWh of electrical energy production if it is a power plant of 2 GW. Considerable research is going on for further development to take off the power from the systems, to improve the turbine efficiency, and dampen the variability of the hydraulic systems, etc. Additionally, synergies with other offshore industries, such as oil, gas, and wind are suggested to pursue decreasing the installation, operation, and maintenance costs as well as mooring [12].

The main limitation of the OWEH system is that only 2% of the world's coastal lengths go beyond the ocean wave power density of 30 kW/m, whereas the projected prospect for electrical energy from this system for the world is about 500 GWe considering only 40% of the conversion efficiency [12, 25].

III. Turbine Design using SolidWorks

To design the Pelton turbine, we need to know the working principle first. Often, it is called a Pelton wheel. It has four main parts, viz., nozzle and flow regulating arrangement, runner and buckets, casing, and braking jet. This is a kind of lateral flow impulse turbine that converts the water pressure (or potential energy due to the height, mgh) into kinetic energy ($1/2mv^2$) and thus creates a high-speed water jet that impinges on the buckets of the runner in its periphery to rotate it. The energy conversion process occurs entirely it is the distributor as shown in Fig. 1. The nozzle intensifies the kinetic energy of the ocean water wave and guides it in the form of a jet spray. The spare (Fig. 1) regulates the water flow to the buckets. It is operated under very high heads (up to 1800 m) and requires a comparatively lesser quantity of water. The casting controls the splashing of water.

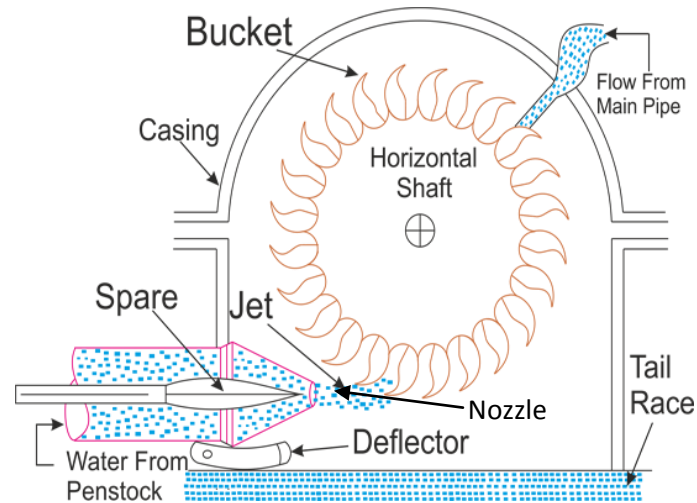

Figure 1: The schematic of a Pelton turbine to explain its working principle [26]

The SOLIDWORKS is mechanical design software with features and dimensions to create and draw the models in 3-D or solid form. It helps the designers to assemble a model from various parts directly on their workstation by checking the functionality as well [27]. Therefore, we used this software to draw and design our Pelton turbine which is then used for harvesting the ocean wave energy. Ocean waves are produced by tides in the sea-based on the lunar phases, and thus waves vary in size, number, and strength. As the ocean waves roll, they create kinetic energy or movement that can be transferred to the water turbines to produce electrical power.

First, we started SolidWorks software and tapped a new part. Then we set the dimension in millimeters and selected a top plane for sketching. After that, we sketched lines and other dimensions to design the Pelton turbine. We also need to draw close planes and curves between the lines. We used trim entities for finishing the design. We used the features to revolve the design about a selected axis. We choose 180 degrees to mirror the right plane go on to reference geometry and then by clicking on the plane to choose a dimension to move to another side dimension of 12.7 mm. We chose that surface to mirror than another side. We chose the surface of the shell to choose our dimension of 1.7 mm and then tap to enter the buckets in the drawing area. A circle of 120 degrees is drawn and a midpoint circle of 30.43 mm has been added to the buckets. In this way, all parts of the buckets were selected and thus we obtained 15 such buckets in the geometric patterns. We then go to the front side of the plane and sketched a circle at the center by tapping on the surface sketch and at the center, we have created a circle with a dimension of 85.58 mm.

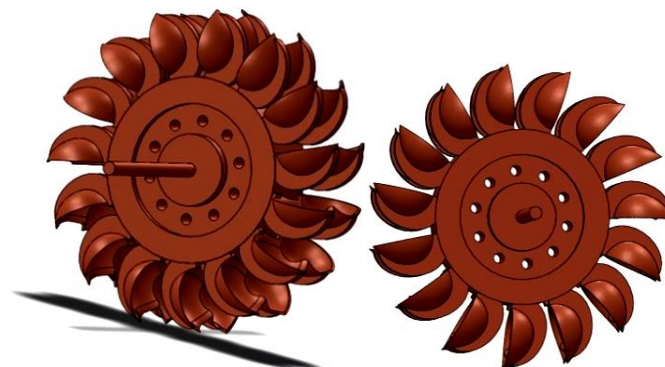

Figure 2: Designed Pelton turbine- (a) front side and (b) backside

To extrude the features, we cut it again and then settled the dimension to 3 mm. We have drawn another circle on the previous one at a dimension of 46.50 mm and then extruded the boss dimension to 5 mm. We have drawn several circles having a dimension of 7 mm and then features are extruded by cutting through all. Then we chose a circular pattern to rebolt around that circle. Thus we get ten numbers of such circles. Now we created a hole in the center having a dimension of 8.68 mm and then added a feature by extruding and cutting through all. Again we select a front plane just to draw a simple circle having a dimension of 8.68 mm and then we go on to the features extruded boss dimension of 195 mm. Finally, we assembled by adding the two parts by clicking on the mates' lock. The finished designed Pelton turbine's front and backside view is shown in Fig. 2.

IV. Modeling Ocean Wave Energy Harvester in MATLAB-Simulink

Simulink is a kind of software integrated with MATLAB to design a model and simulate it for any dynamic and embedded systems. It is developed by MathWorks and can also be used for analyzing the systems having multi-domain dynamics. It is a graphic editing tool that uses modifiable block library sets to draw the block diagram [28].

To design and create a model, we open the Simulink and then open the library browser from where we dragged and dropped the necessary building blocks into the graphic editor. We then add these blocks using arrows or lines or connectors from the connection points. We also add the necessary sources (signals) and sinks (usually, oscilloscopes). The source generates an analog signal for the designed system which produces the output to be visualized by the sink. The necessary stimulation parameters for the designed system are presented in Table 1.

Table 1: Simulation model parameters for the designed system

Parameter	Symbol	Values	Unit
Damping filter gain	K_f	0.001	-
Damping time constant	T_f	0.1	s
Water time constant	T_w	2.67	s
Frequency	f	60	Hz
Turbine efficiency	η	85	%
Speed ratio	K_n	0.45	-
Active power	P	4.39	MW
Proportional gain of the turbine regulator/controller	K_p	1.163	-
Integral gain of the turbine regulator/controller	K_i	0.105	-
Differential gain of the turbine regulator/controller	K_d	0.0	-

The hydraulic power equation is given by equation (1), and it is required for the calculation of the output power.

$$P = QH\rho g \tag{1}$$

,where

Number of buckets, $z = 15 + D/2d$

Velocity of jet, $V = C_v(2gH)^{1/2}$

Velocity of wheel, $\mu = K_n V$

Discharge, $Q = AV = (\pi d^2/4)V$

Efficiency, $\eta = P/QHg$

Area of jet = A

A program in MATLAB is written and a Simulink model is drawn as shown in Fig. 3. The model is composed of an ocean wave energy model to obtain electricity from the ocean wave. In this model, we used a hydraulic governor, which is the central regulator of the Pelton water turbine. The turbine governor regulates the ocean water flow through the Pelton water turbine to control its speed and hence the electrical power output and output frequency of the voltage/current of the synchronous generator, which converts the mechanical power into AC electrical power. The excitation system provides the fixed field current to the winding of the synchronous machine and generates the magnetic flux necessary to generate the induced AC voltage, because an AC system can transmit and distribute the electric power efficiently. The synchronous machine can act both as a synchronous motor as well as a synchronous generator. Three-phase lines are extracted from the generator and are then connected to the three-phase step-up transformer. Its output is fed to the RLC load. This model is designed in such a way that when there is variation in the sea wave then this will not create any problem to the system. Various scopes are used in the model to display various types of signals.

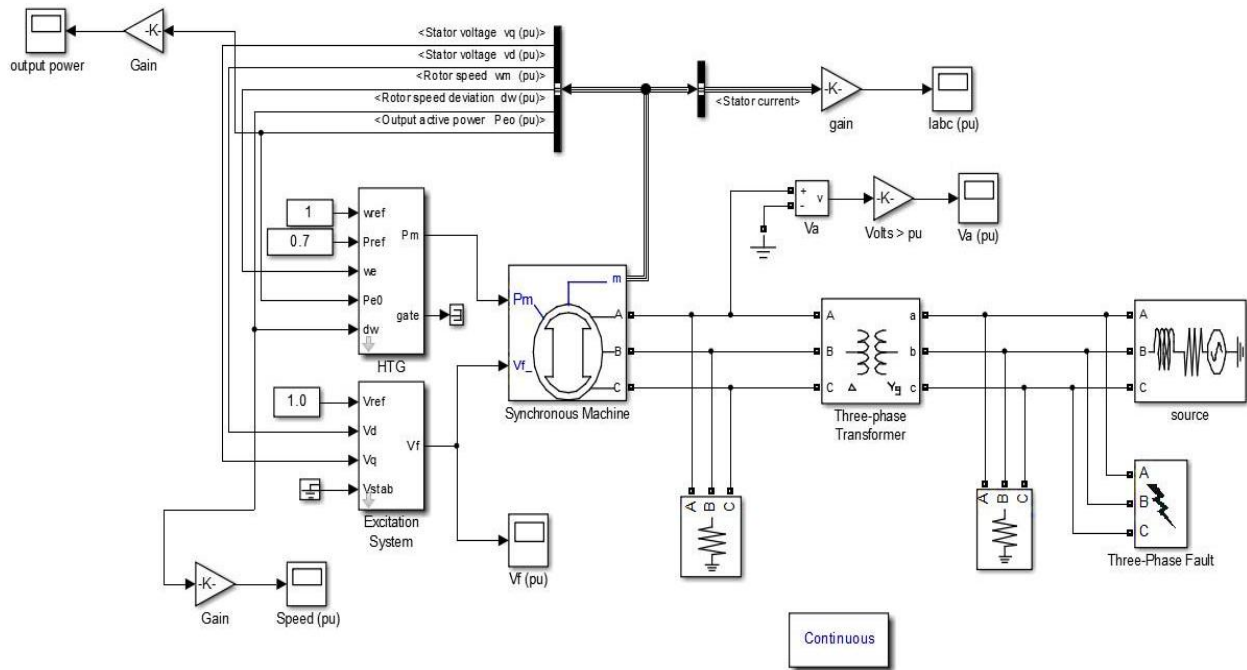

Figure 3: The Simulink model of an ocean wave energy harvesting system

V. Simulation Results and Discussions

The ocean wave energy harvesting model has been simulated for various parameters in the MATLAB/Simulink environment. The simulated results are shown in various figures of the following subsections with a brief explanation of each figure. We will discuss the result of the ocean wave energy harvesting simulation model. The voltage of a one-line is shown. We know the maximum and minimum voltage. We know the three-phase stator current change in load and the maximum current. We have seen that power increase with time. If the wave is more, the turbine will rotate more and more power will be available. We have seen that the turbine will continue to rotate as soon as the wave is received and the speed will increase as the turbine rotates. We know why the value of field voltage is constant.

A. Voltage Waveform Generation

The simulated voltages of the three phases of the synchronous generator are shown in Fig. 4. We obtained a maximum voltage of +440 V and a minimum voltage of -440 V. That is, we get a peak to peak voltage of 880 V.

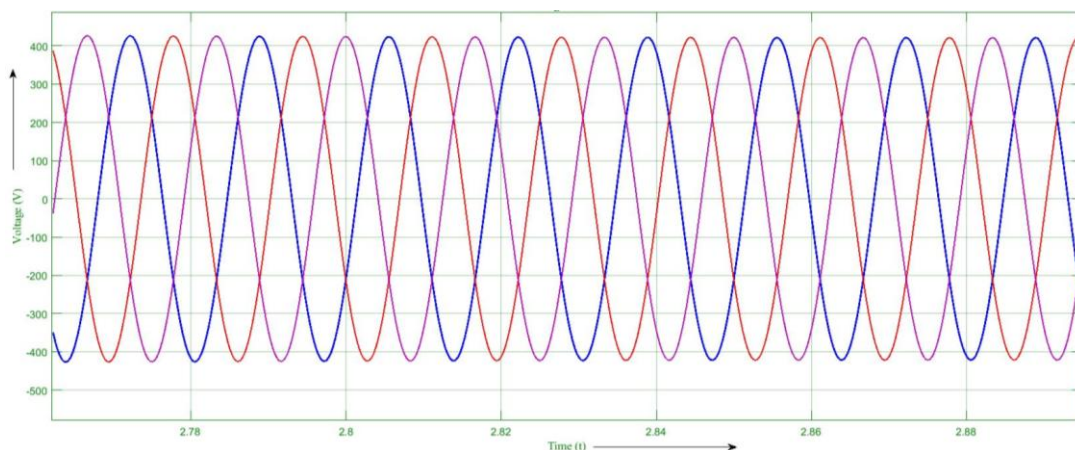

Figure 4: Voltage waveforms of the three phases of the synchronous generator

B. Stator Current Waveform Generation

Stator current has two components- one is related to the core magnetization to produce rotating magnetomotive force (mmf), and the other is a straight conversion of rotor current through the mutual inductance. The stator current of this model is shown in Fig. 5. The maximum current is 170 A and the peak-to-peak current is 340 A.

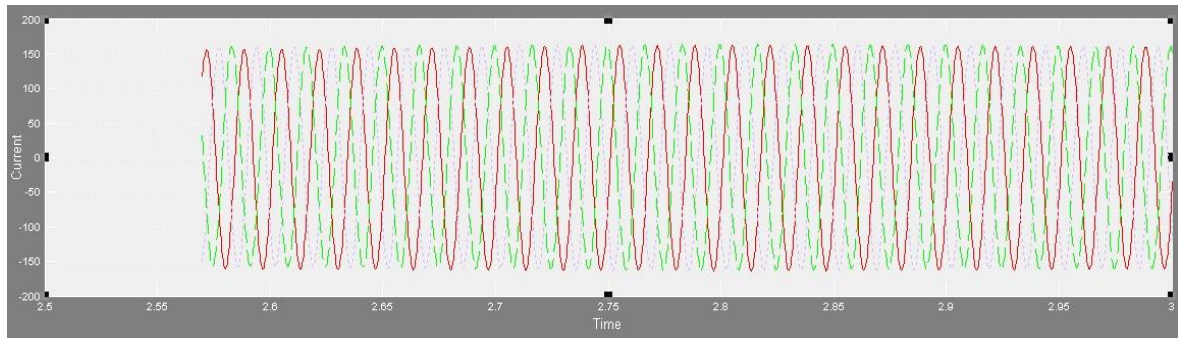

Figure 5: Stator current waveform of the three phases of the synchronous generator

C. Power Waveform Generation

We can see the power variation with time in Fig. 6. The more waves we get, the more is the obtained power. We get the maximum power of 3.7 MW and the minimum power of 3.53 MW.

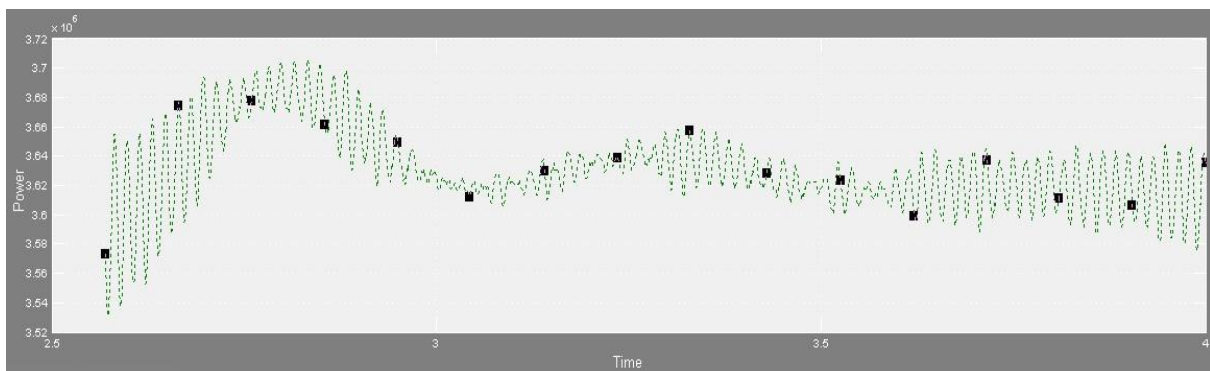

Figure 6: Output power waveform of the synchronous generator

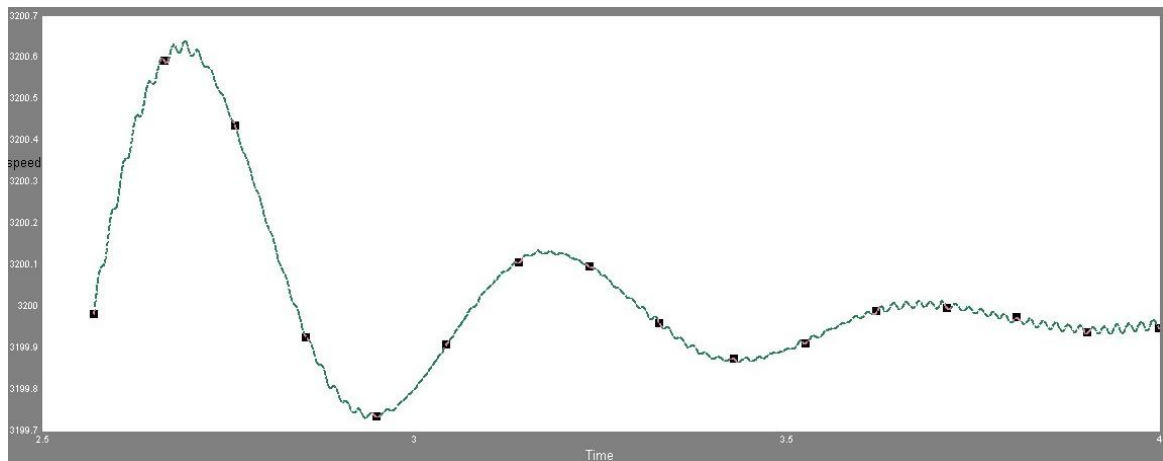

Figure 7: Turbine speed waveform fed to the generator

D. Turbine Speed Waveform

When the waves start to flow, the speed starts to increase over time as shown in Fig. 7. We obtained a steady-state speed of 3200 rpm. However, there is an initial transient speed, which dies out within a few seconds.

E. Field Voltage Waveform Generation

We have also checked the field voltage as shown in Fig. 8. It is observed that the value of field voltage remains constant at 11.5 V while simulating the model.

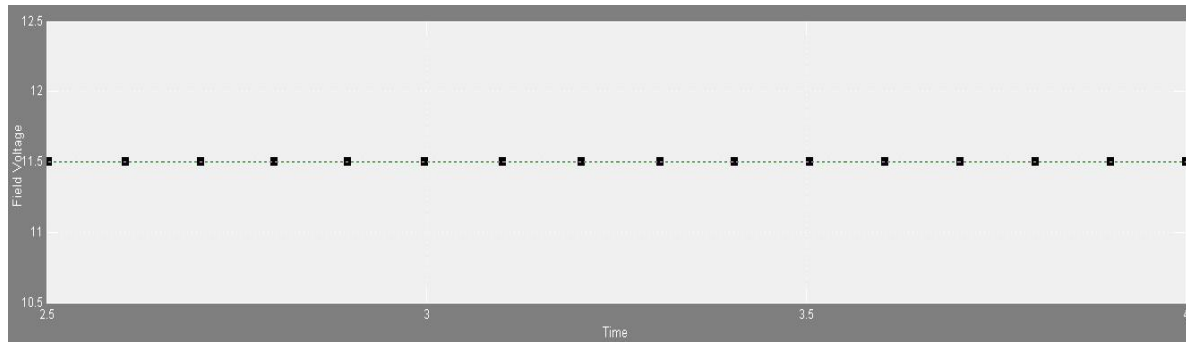

Figure 8: Field voltage waveform of the generator

VI. Conclusions

A huge amount of ocean wave energy resources are available throughout the world. In different regions, ocean waves have different natures and as such, we need a wide variety of technologies to harvest this energy for the benefit of mankind. But we don't have enough industrial interrelation and the supply of required components for this purpose. For planning and technology development, synergies with the other offshore industries to the wave energy harvesting industries are required to minimize the cost. At the same time, we need to create opportunities for the dedicated infrastructures including ports and transmission grids for the electrical power to support the installation, operation, and maintenance of wave energy converters.

As the electrical power demand is growing and environmental pollution is increasing in parallel due to the use of fossil fuel, renewable or clean energy technology is the hot topic of modern technological research. Among various available renewable energy sources, the potential for ocean wave energy in the sea bed is tremendous. Almost 1000 OWEH technologies have been patented but none of them are yet to be implemented on large scale. In this paper, we have discussed a wave energy conversion technology based on the Pelton turbine through simulation. With the rapid rise in electrical power requirements in Bangladesh, there is no significant plan to meet the demand. Bangladesh is now facing tremendous challenges due to the lack of dependable and sustainable renewable energy resources. This work can be an ice-breaker for taking the initiative to start working in this field to explore the vast opportunities to harness the electricity from the ocean wave energy and thus to create a milestone in the history of Bangladesh. This wave energy harvesting technology seems to be a promising renewable energy resource for Bangladesh in the future. We need to study further as this will be more feasible in the long run.

References

- [1]. EIA, US Energy Information, Sources of Energy, <https://www.eia.gov/energyexplained/what-is-energy/sources-of-energy.php/>, accessed on 10 March 2021.
- [2]. IEA Data: <https://www.iea.org/data-and-statistics?country=WORLD&fuel=Energy%20supply&indicator=TPESbySource/>, accessed on 12 March 2021 and IEA: International Energy Agency, "World Energy Outlook 2006," Head of Publications Service, IEA, Paris, France, 2006.
- [3]. A. Al-Adaileh and S. Khaddaj, "Reduction of Energy Consumption Using Smart Home Techniques in the Household Sector," *International Journal of Energy and Environmental Engineering*, Vol. 14, No. 12, 2020, pp. 371-383.
- [4]. S. Z. Baykara, et al., Environmental Issues and Social Issues with Renewable Energy, <https://www.sciencedirect.com/topics/agricultural-and-biological-sciences/renewable-energy-sources/>, accessed on 15 March 2021.
- [5]. Eurostat, "Energy consumption in households," Eurostat Statistics Explained, https://ec.europa.eu/eurostat/statisticsexplained/index.php/Energy_consumption_in_households, accessed on 16 March 2021.
- [6]. Bundesverb and Wind Energie e. V., "Statistics," 06 March 2020. (Online). Available: <https://www.wind-energie.de/english/statistics/>, accessed on 11 March 2021.
- [7]. Goal 7 UN-SDG: Affordable and Clean Energy, UNDP: <https://www.undp.org/content/undp/en/home/sustainable-development-goals/goal-7-affordable-and-clean-energy.html>, accessed on 7 March 2021.
- [8]. J. Falnes and J. Løvstedt, "Ocean Wave Energy," *Energy Policy*, vol. 19, no. 8, pp. 768-775, 1991.
- [9]. X.-P. Zhang, "Marine Energy: The Key for the Development of Sustainable Energy Supply," *Proceedings of the IEEE*, Vol. 100, No. 1, January 2012, pp. 3-5, doi: 10.1109/JPROC.2011.2169509.
- [10]. J. Xie and L. Zuo, "Dynamics and control of ocean wave energy converters," *International Journal of Dynamics and Control*, Springer, vol. 1, pp. 262-276, 2013, doi: 10.1007/s40435-013-0025-x.
- [11]. J. Brooke, "Wave energy conversion," volume 6, Elsevier ocean engineering book series, Elsevier, Oxford, UK, 2003.
- [12]. IRENA: International Renewable Energy Agency. "IRENA Ocean Energy Technology Brief 4," June 2014, www.irena.org, accessed on 8 March 2021.
- [13]. L. Di Fresco and A. Traverso, "The Seaspoon innovative wave energy converter," *OCEANS - San Diego*, San Diego, CA, USA, 2013, pp. 1-10, doi: 10.23919/OCEANS.2013.6740970.
- [14]. S. Como, P. Meas, K. Stergiou, and J. Williams, "Ocean Wave Energy Harvesting- Off-Shore Overtopping Design," BSc Engg. Thesis, Worcester Polytechnic Institute, MA, USA, <http://www.wpi.edu/academics/ugradstudies/project-learning.html>, accessed on 21 March 2021.

- [15]. S. A. Sirigu, M. Bonfanti, E. Begovic, C. Bertorello, P. Dafnakis, G. Giorgi, G. Bracco, and G. Mattiazzo, "Experimental Investigation of the Mooring System of a Wave Energy Converter in Operating and Extreme Wave Conditions," *Journal of Marine Science and Engineering*, vol. 8, 2020, pp. 1-32, doi:10.3390/jmse8030180.
- [16]. S. J. Beatty, M. Hall, B. J. Buckham, P. Wild, and B. Bocking, "Experimental and numerical comparisons of self-reacting point absorber wave energy converters in regular waves," *Journal of Ocean Engineering, Science Direct*, vol. 104, 2015, pp. 370-386, ISSN 0029-8018, <https://doi.org/10.1016/j.oceaneng.2015.05.027>.
- [17]. T. Aderinto and H. Li, "Ocean Wave Energy Converters: Status and Challenges," *Energies*, vol. 11, no. 5, p. 1250, May 2018.
- [18]. S. Doyle, and G. A. Aggidis, "Advancement of Oscillating Water Column Wave Energy Technologies through Integrated Applications and Alternative Systems," *International Journal of Energy and Power Engineering, World Academy of Science, Engineering and Technology*, Vol. 14, No. 12, 2020, pp. 401-412.
- [19]. N. Delmonte, D. Barater, F. Giuliani, P. Cova, and G. Buticchi, "Oscillating water column power conversion: A technology review," 2014 IEEE Energy Conversion Congress and Exposition (ECCE), Pittsburgh, PA, USA, 2014, pp. 1852-1859, doi: 10.1109/ECCE.2014.6953644.
- [20]. S. Zheng, A. Antonini, Y. Zhang, J. Miles, D. Greaves, G. Zhu, and G. Iglesias, "Hydrodynamic Performance of a multi-Oscillating Water Column (OWC) Platform," *Applied Ocean Research*, vol. 99, 2020, 102168, ISSN 0141-1187, <https://doi.org/10.1016/j.apor.2020.102168>.
- [21]. S. Doyle, and G. A. Aggidis, "Development of Multi-Oscillating Water Columns as Wave Energy Converters," *Renewable and Sustainable Energy Reviews*, vol. 107, 2019, pp. 75-86, ISSN 1364-0321, <https://doi.org/10.1016/j.rser.2019.02.021>.
- [22]. R. Ferreira and S. Estefen, "Ocean Power Conversion for Electricity Generation and Desalinated Water Production," *World Renewable Energy Congress on Marine and Ocean Technology*, Linkoping, Sweden, 8-13 May 2011, pp. 2198-2205.
- [23]. A. Ambalia, J. Dolar, M. Koladiya, S. Ansari, and Z. Ansari, "Generation of Electricity from Ocean Waves," *International Research Journal of Engineering and Technology (IRJET)*, p-ISSN: 2395-0072, e-ISSN: 2395 -0056, Vol. 3, Issue 04, April 2016.
- [24]. M. A. Mustapa, O. B. Yaakob, Y. M. Ahmed, C.-Kyu Rheem, K. K. Koh, and F. A. Adnan, "Wave Energy Device and Breakwater Integration: A Review," *Renewable and Sustainable Energy Reviews*, Elsevier, vol. 77, 2017, pp. 43-58, ISSN 1364-0321, <https://doi.org/10.1016/j.rser.2017.03.110>.
- [25]. O. Ellabban, H. Abu-Rub, and F. Blaabjerg, "Renewable Energy Resources: Current Status, Future Prospects and their Enabling Technology," *Renewable and Sustainable Energy Reviews*, 2014.
- [26]. Working Principle of Pelton turbine: <https://theconstructor.org/practical-guide/pelton-turbine-parts-working-design-aspects/2894/>, accessed on 20 September 2020.
- [27]. SOLIDWORKS software design, <https://www.instructables.com/id/How-To-Model-a-Basic-Assembly-Using-Solidworks/>, retrieved on 09 September 2020.
- [28]. MATLAB software using Simulink design, https://www.tutorialspoint.com/matlab/matlab_simulink, retrieved on 09 September 2020.

Muhibil Haque Bhuyan, et. al. "Design of a Pelton Turbine using SOLIDWORKS for Ocean Wave Energy Harvesting in MATLAB Simulink." *IOSR Journal of Electrical and Electronics Engineering (IOSR-JEEE)*, 16(2), (2021): pp. 27-35.