

# SCADA/ Automation of E/M Services in Military Station

Lt Col Ashit Kumar Rana and Dr. Asha Gaikwad

---

## **Abstract:**

The SCADA system was developed to provide fault isolation operation, monitoring and controlling functions for various industrial applications which includes data collection and storage for future analysis. This paper encompasses study of the development of a Supervisory Control and Data Acquisition (SCADA) based on Remote Terminal Unit (RTU). An embedded Ethernet controller is used as RTU to act as converter for Human Machine Interface (HMI) and to interact with analog and digital input and output modules. RTU is the master and digital input and output modules are the slaves. RTU will initiate the transaction with the digital input and output modules and feed the data's to Communication Feed Server. The integration of the SCADA system and the substation automation system results in a real-time wide-area monitoring and control of substation by controlling not only in civil but also in Military Station.

**Keywords:** SCADA, Remote Terminal Unit (RTU), monitoring and controlling, Human Face Interface (HMI), Input and Output modules, Communication Feed Server, Military Station.

---

Date of Submission: 16-12-2022

Date of Acceptance: 31-12-2022

---

## **I. Introduction:**

1.1 SCADA systems at their fundamental level are considered as industrial measurement and control systems which consists of a central host or master terminal unit (MTU), a remote terminal unit (RTU) which gathers and controls field data and a custom software which monitors and controls the field data elements remotely. SCADA can also be defined as a process control system using which the site operator can monitor and control processes that are distributed among various remote sites. Programmable Logic Controller (PLC) carries out most of the work of SCADA which includes effectively grabbing information from instruments, converting the information to a format a computer can understand and handling high speed communication. The data servers communicate with devices in the field through programmable logic controllers (PLC), which are connected to the data servers either directly or via network or field buses in all the installed SCADA systems. An Ethernet LAN connects the data servers to each other and to client stations. Two variations of PLC have been developed as follows: (i) RTU: Remote Telemetry Unit (ii) PAC: Programmable Automation Controller. The function of RTU was to gather and transmit data to a remotely located processor. A RTU has communication capability of a computer and IO capability of a PLC. The drawback of RTU is that it does not control processes using an internal program, it functions only as a data logger that can transmit data at a certain time to centrally located unit. PAC is the next generation PLC which can control local processes and can perform the communication functions of RTU. PAC is more related to computer in its speed and computing methods and its greatest advantage is the communication function which allows it to work more effectively with modern communication networks based on Ethernet.

## **II. Literature Survey:**

2.1 In recent years various research has been done to reduce the electrical energy expenditure and control losses. In view of this in [1], data of the 33/11kV distribution station is transferred using SCADA system and connecting the distribution station and control centre using an optical cable instead of the previously used wireless methods. Various calculations are done in [1] such as speed of data transfer and compare the results obtained with the previously existing system, amount of electrical energy consumed by the consumer and compare it with electrical energy produced to know the losses resulting from the process of transferring electrical energy from the source to the consumer. SCADA system which are based on PLCs are very complex, has lower reliability and require developed electronic industry in order to produce sophisticated PLCs. In [2], microcontroller-based SCADA system with open-source software and graphical user interface is introduced resulting in cost reduction of the proposed SCADA system. Photovoltaic power plants used SCADA for monitoring, control and remote communication purposes. Two effective solutions, security access control strategy and redundancy mechanism are introduced in [3] to improve security and reliability of the SCADA systems used in PV plants. The proposed solutions in [3] can solve communication security issues between the

SCADA system and Remote Terminal Unit. In [4], a JAVA enabled mobile phone has been integrated into a SCADA system as client, hence it is not mandatory that SCADA system to have PC. In the proposed method the monitoring and controlling of the plant process are realised with the use of GSM based stations which further reduces the cost of network settings.

### III. SCADA System Types:

3.1 The process of data gathering and controlling system is divided into basic systems as follows: (i) SCADA (Supervisory Control And Data Acquisition) (ii) DCS (Distributed Control System).

3.2 SCADA can be defined as a system that monitors/controls system utilizing a central computer for storing information and uses onsite/remote hardware to monitor facilities and processes. Control in SCADA can be either automatic or manual and it can occur in remote units or at the central computer level. A SCADA system and DCS are same at all levels, however a SCADA system is event driven and operator concentric, whereas DCS, as shown in figure 1 is process state driven. In SCADA system data is stored in database and control is remotely originated whereas DCS is directly connected to the field devices and control is done locally and automatically. In case of DCS the operator is just informed about what has happened. In SCADA system S stands for supervisory which means that an operator takes action if a change of state occurs. A change of state will generate alarms, events, database updates and any special processing required relating to that. In case of DCS systems, being process control system, it considers the process variable's present and past states to be the main criteria driving the DCS. In case of DCS, notifying the operator is secondary consideration.

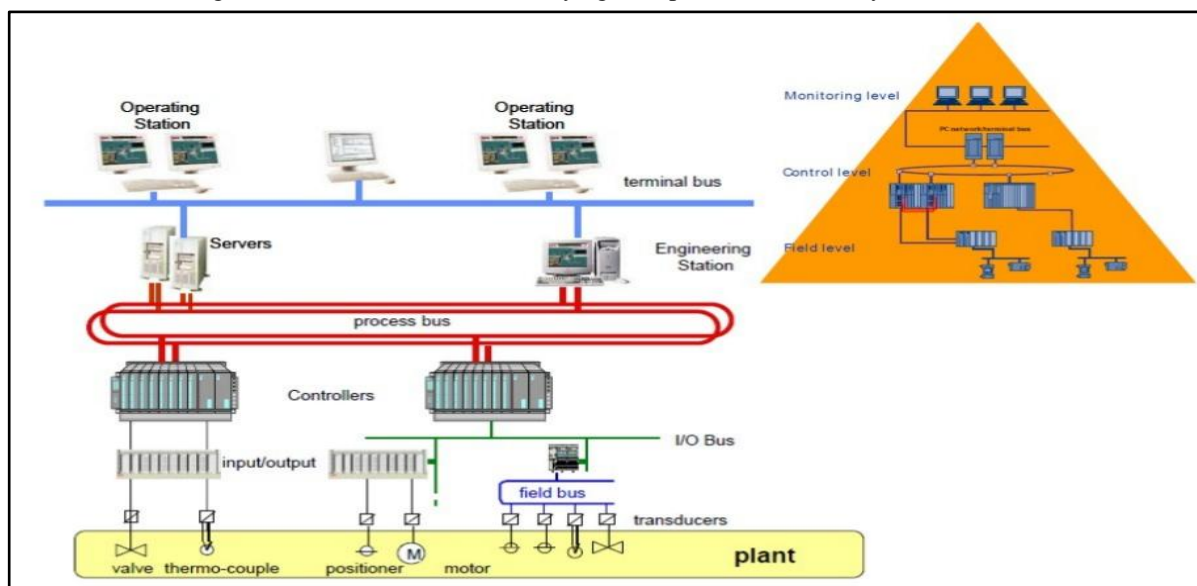

Fig. 1 DCS Structure

### IV. Advantages of SCADA include:

- (i) Real time monitoring
- (ii) Modifications in the system
- (iii) Trouble shooting
- (iv) Increase in equipment life
- (v) Generating report automatically

Along with the above advantages, good SCADA system can also be used for measuring, forecasting, billing, analysing and planning.

## V. SCADA Hardware Architecture:

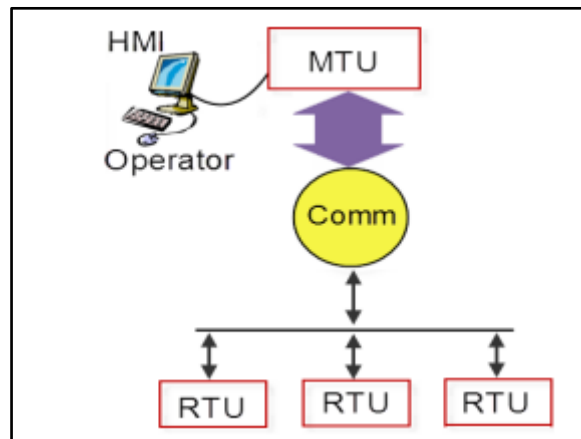

Fig. 2 Block Diagram of Standard SCADA System

Figure 2 shows the block diagram of standard SCADA system. Three main components are shown in figure 2.

- (i) Main Terminal Unit (MTU)
- (ii) Remote Terminal Unit (RTU) along with communication system between them
- (iii) Human Machine Interface (HMI) software.

### 5.1 Main Terminal Unit (MTU):

5.1.1 It is also called as master station of SCADA system. It can be further divided into two separate subsystems.

5.1.2 The information obtained is processed in workstation, where the system operator monitors and controls the system.

5.1.3 The burden of real-time, low level communication processing and network management is taken by a communication controller, thus relieving the workstation of another task.

### 5.2 Remote Terminal Unit (RTU):

5.2.1 An RTU provides intelligent input/output data collection and its processing. For example it reads the inputs from switches, sensors, transmitters etc. and then arranges them into a format that the SCADA system can understand. RTU also converts the output values from SCADA system which is in digital form into the form that can be understood by field controllable devices such as discrete (relay) and analog outputs (current or voltage). Figure below 3(a) shows a RTU configured with Programmable Automation Controller (PAC), which can provide local control when communication is lost. This panel can communicate via leased line using modem which is placed in the lower left corner of the panel. Figure 3 (b) shows an example of control panel, which is basically a customized approach and designed for a site with large number of physical input/output. It can be seen from fig. 3(b), that a radio is installed in the upper right hand corner for communication and batteries in the lower right corner for back up power. An RTU in this control panel can interface with field devices, however it has no processors for local control. It is equipped with a communication module.



Fig. 3 (a) RTU configured with PAC      Fig. 3(b) Control Panel

5.2.2 Figure 4 shows the original design of RTU's. It can be seen from this figure that it has processor which can handle communications via a radio mounted on the door. This RTU receives signal from field devices and passes it to central unit for display by the SCADA HMI and vice versa i.e it passes signal from the central to the field devices.



Fig. 4 Original Design of RTU

5.2.3 Figure 5 shows Autodialers which are very basic form of RTU. These devices on receiving alarm signals in digital form calls a duty operator over a standard telephone line (POTS) or a cell phone. The operator acknowledges the alarm using the telephone keyboard. Using higher end autodialers, the operator can do basic controls via the keyboard such as starting a back up pump or operate a valve.



Fig. 5 Autodialer

### 5.3 Human Machine Interface (HMI):

5.3.1 The operator can access the SCADA system by

- (i) OIT: Operator Interface Terminal
- (ii) HMI: Human Machine Interface

5.3.2 OIT's generally provide local interface at remote location having simple screens to display small information whereas HMI software's are used in central control location. HMI software's are installed on computers having fast processor and large monitors to display more information. HMI also makes use of animation to emphasize critical data to focus user attention on important areas or initiates an alarm.

5.3.3 HMI is a software using which the operator can monitor and control the whole system. Modern SCADA system are generally equipped with open loop control characteristics and they utilize long distance communication with relatively low data rates. The user/operator interacts with SCADA by means of HMI. HMI presents in a clear and easy to understand the computer representation of the quantities being controlled and monitored by the SCADA. Using HMI the operator can virtually view all system alerts, warnings, functions as well as it can change set points, analyse archive or present data trends. A good and effective SCADA HMI design helps the operator to clearly and easily interact with SCADA through HMI without and explanation.

### 5.4 Communication Between Main Terminal Unit (MTU) and Remote Terminal Unit (RTU):

5.4.1 Wired or wireless communication can be made between MTU and RTU of the system via local LAN or via the internet.

- In this first method for private data transmission, wirelines, buried cables and modems are used which are usually limited to low bandwidth.
- The second method is wireless transmission which includes spread spectrum, microwave or VHF/UHF radios. VHF/UHF radio is an electromagnetic transmission with frequencies in the range of 175MHz-450MGz-900MHz and which can be received by special antennas. This type of transmission is good for upto 30 miles.
- The Private Leased Line (PLL) should be considered for 24 hour permanent connection for analog data transmission between two or more locations. For high speed/low error rate applications Digital Data Service (DDS) with Digital Subscriber Lines (DSL) and Integrated Service Digital Network (ISDN) should be considered.

### 5.5 Typical Layers of SCADA

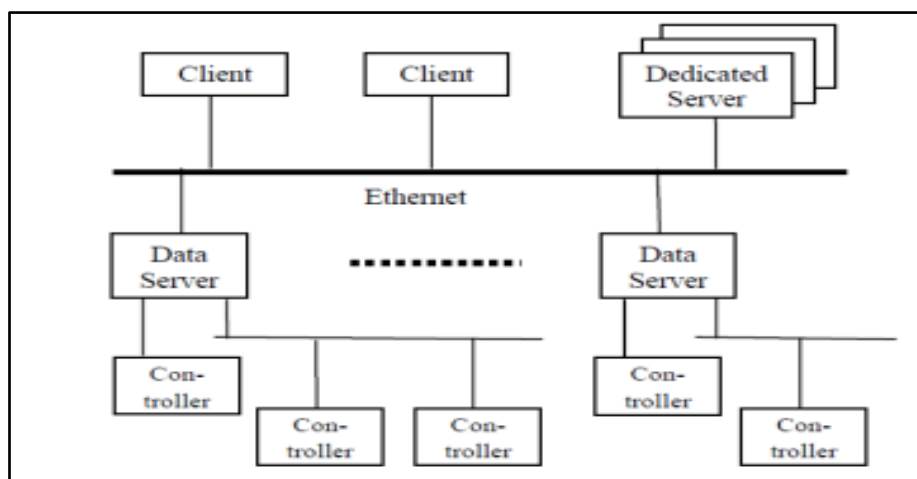

Fig. 6 SCADA System Hardware Architecture

5.5.1 In a SCADA system two basic layers can be distinguished namely, the client layer which takes care for the human machine interface and the data server layer which handles the various process data control activities. Figure 6 shows the two SCADA system layers. Through process controllers the data servers communicate with device in the field. Examples of process controllers are PLCs which are connected to the data servers either directly or via networks or field buses that are proprietary (e.g Siemens H1) or non proprietary (e.g Profibus). An

Ethernet LAN connects Data servers to each other and to client stations. The data servers and client stations are NT platforms but for many products the client stations may also be Windows machines.

**5.6 Common SCADA Architectures:**

5.6.1 Proprietary event-driven operating systems and some form of rudimentary/proprietary serial communications typically based on R232/RS422/RS485 were used by early SCADA systems. However nowadays purpose built event driven operating systems, commercial operating system (for ex. Windows/linux as well as hybrids) are used by SCADA with real time extensions. SCADA system which are used for critical processes are available with fault tolerant networking and most of them have evolved to take advantage of UDP/TCP over Ethernet communications. Figure 7 shows a SCADA network in which field devices are typically connected to the PLCs across an independent network using specialized protocols such as Fieldbus, HART or MODBUS.

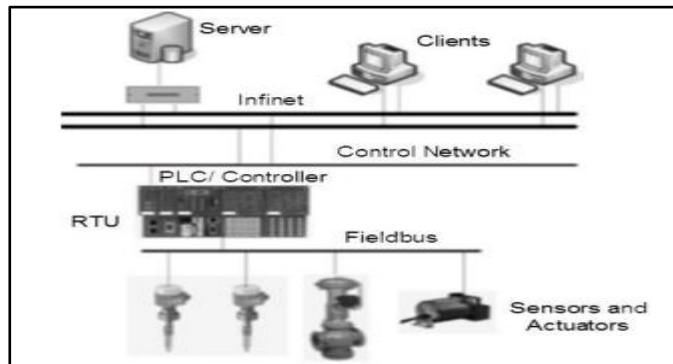

Fig. 7 SCADA Network

5.6.2 Using protocols such as InfiNET, the PLCs which are on separate network, communicate to the system’s HMIs, hybrid controllers and event loggers. Figure 8 shows a corporate IT network which is typically connected to the InfiNET network with a bridge to allow for the collection of production data. To facilitate vendor support of the SCADA system, the SCADA vendors are allowed to connect to PLCs or hybrid controllers.

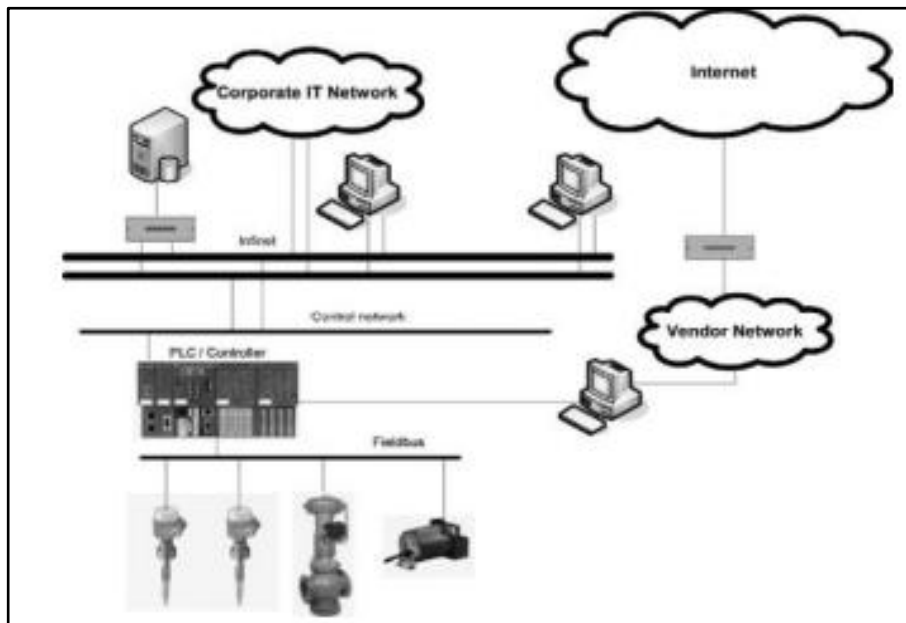

Fig. 8 Network Bridge



**VI. Case Study:**

6.1 GE (Utility) Electric Supply, Delhi Cantt is the nodal agency for providing the bulk uninterrupted electric supply to all Defence establishments located in Delhi Cantt. MES is one of the electric supply distribution company/ licensees (DISCOM) recognized by state of Delhi with other DISCOMs like NDMC, NDPL and BSES. The entire electric supply to Delhi Cantt including all Defence establishments/units is distributed by MES through 04 Nos 33 KV GRID sub stations namely Sekhawati Line, Khyber Line, Shankar Vihar and Kirby Place.

6.2 The scope of work includes Local SCADA system for each substation, Main control centre station, required hardware and software, Distribution management system etc.

6.3 The objective of project was to transform the manual control system to automated switch control system. There are four main portions in SCADA based electrical distribution system. They are automated control system, interfacing units, monitoring system and networking system. The automated control system is emphasized in this case study. This automated distribution system is analyzed to develop a secure, reliable and convenient management tool which can use remote terminal units (RTUs). This system is efficient and reliable for conventional electrical distribution system in MES by using SCADA based technology.

6.3 SCADA system installed at GE (Utility) Electric Supply (figure 9), Delhi includes collection of the information from sensors and instruments (i.e. relays, circuit breakers etc) located at remote sides via a RTU (remote terminal unit), transferring it back via communications system such as radio, Fibre optic, satellite etc, to the central host computer sever or severes (also called a SCADA center, or Master Terminal Unit (MTU) for carrying out any necessary analysis and control and then displaying that information on a number of operator screens or displays.

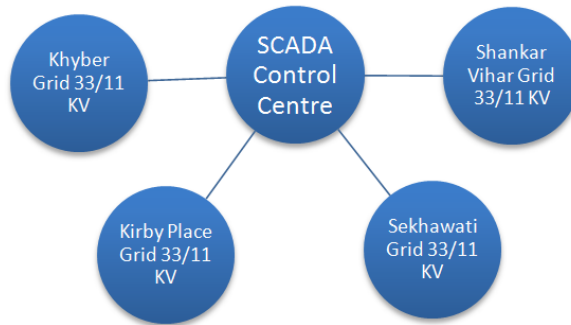

Figure 9: Basic Layout of SCADA at Delhi Cantt

**Communication between RTU and Servers**

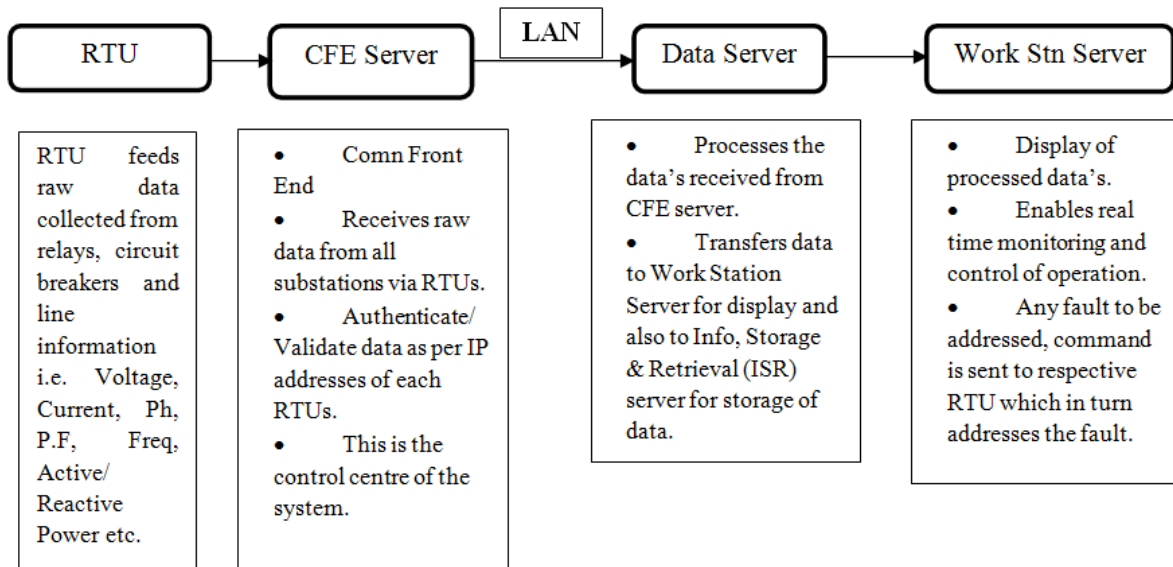

Figure 10: Communication between RTUs and Servers part of SCADA System

**Table 1 Servers/ Softwarespart of SCADA System shown in fig.9**

S. No.	Name of Server/Software	Application
(i)	SCADA / Distribution Management System (DMS) Server	Control and monitoring of four take over points in one place at Control Centre Room and distribution management
(ii)	Information Storage and Retrieval (ISR) Server	Collection of data from real time SCADA/DMS system and storing it periodically in a RDMBS (Relational Data Based Management Server) database as historical information (HI) data
(iii)	Communication Server Inter-control centre communication protocol (ICCP) Communication front end (CFE) server	ICCP/CFE server for communication between MES control centre & Delhi Transco Limited (DTL) server, front end communication with RTUs
(iv)	Web server	Web interface, host based IDS, database development system cum test bench for RTU and ICCP
(v)	LDMS (Local Data Monitoring System)	Local data monitoring, controlling, report generation etc at substation level

**Display on Work-Station Server**

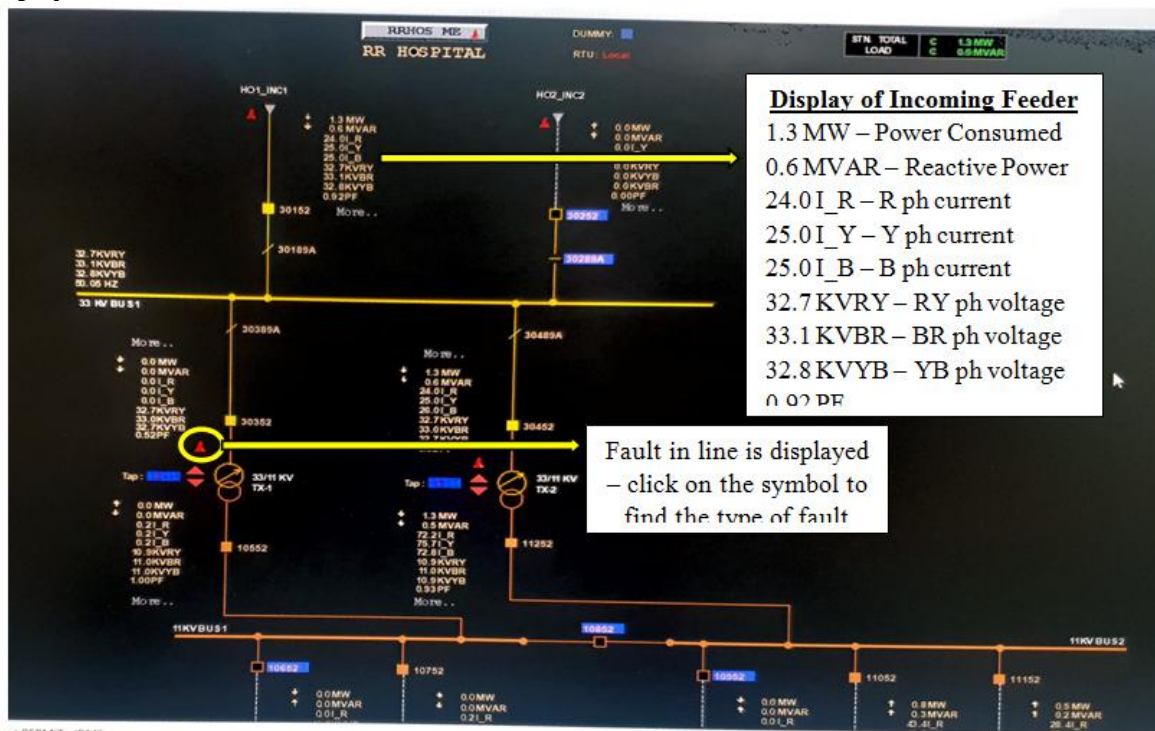

Figure 11: Display screen of Work Station Server of SCADA System

**Benefits drawn after its Implementation in Military Station:**

- (i) Visibility for the network operation.
- (ii) Real-time, accurate and consistent information of the system.
- (iii) Flexibility of operational controls.
- (iv) Faster fault identification, Isolation & system restoration.
- (v) Extensive reporting & statistical data archiving.
- (vi) Central database and history of all system parameters.
- (vii) Improve availability of system, Optimized Load Shedding.

**VII. Conclusion:**

In this paper basics of SCADA which includes SCADA Architecture, types of SCADA system, layers of SCADA has been explained in detail. To understand the concept of SCADA system a case study that brings out the implementation of SCADA in GE (utility) electric supply Delhi Cantt has been studied in detail. This case study shows the major advantages and importance of using SCADA system in Military Station.



**References :**

- [1]. Ahmad T. Jaiad and Dr.SeyedVahab AL-Din Makki, “ Implementation of SCADA System for Data Transmission 33/11kV substation”, *Webology*, Volume 19, Number 1, January 2022, pg 1474-1480.
- [2]. Mohamed Zahran, YousryAtia and Ahmed Abulmagd, “ Reliable, Cheaper and Modular SCADA System for Wireless Remote Applications”, *Research Gate*, July 2011, Pg no. 1-8.
- [3]. Hu Guozhen, Cai Tao, Chen Changsong, DuanShanxu, “ Solutions for SCADA system Communication Reliability in Photovoltaic Power Plants”, *IEEE*, 2009, pg 2482-2485
- [4]. MevlutKaracor and EnginOzdemir, “ Mobile based SCADA automation”, *Feature* 268, Vol 37/9 Nov 2004.
- [5]. Adnan Salihbegovic et. al, —Web based multilayered distributed SCADA/HMI system in refinery applicationl, *Computer Standards & Interfaces* 31 (2009) 599–612.
- [6]. EsmailFathiLoshani And Maryam Sharifkhani, —An Optimum Solution for Telemetry of Distributed Wells in South of Tehranl, *Proceedings of the 8th WSEAS International Conference on Signal Processing, Robotics and Automation*, ISSN: 1790- 5117, ISBN: 978-960-474-054-3
- [7]. N.Yellamandamma et. al, —Low Cost Solution for Automation and Control of MV Substation using MODBUS-SCADA, 2009 Third International Conference on Power Systems, Kharagpur, INDIA December 27-29, 2009.
- [8]. Tai-hoon Kim, —Weather Condition Double Checking in Internet SCADA Environmentl, *WSEAS Transactions on Systems and Control*, Issue 8, Volume 5, August 2010.