

Contribution in Development of Design and Performance of Turbine Jet Engine

Dr. Jassim M. Abdulkarim Jaff¹, Mahmood H. Tahir², Yad F. Tahir³
Shangar S. Sleman⁴, Hero B. Abdullah⁵

Department of Production Engineering-College of Technical Engineering- Sulaimani Polytechnic University - Sulaimani-Iraq.

Abstract: A turbine jet engine has four main parts, They are compressor, combustion chamber, turbine and exhaust nozzle. Turbine jet engine operates at an open cycle called a jet propulsion cycle. A small-scale turbine jet engine comprises of the same element as the gas-turbine engine but in a small scale. Turbine jet engines are constructed mainly for air transportation while the turbine jet engines are developed for a wider purpose, ranging for research activity to hobbyist enthusiastic. Hence, this paper encompasses the design, fabrication, and testing a turbine jet engine. The engine is derived from an automobile turbocharger, which provided the turbine and compressor component. A combustion chamber is design and fabricated. Engine support system comprised of ignition, lubrication and fuel delivery system are installed at the engine. Thermocouple K-type are installed at four different stations on the engine flow path to measure the temperature. Fuel regulators are utilized to measure the fuel flow rate. The design of the combustion chamber is developed to make primary and secondary air takes paths so as to allow a series of combustion processes that help to increase the speed of a jet engine.

Keywords: Jet Engine Speed, Flame Length, Temperature Combustion, Equivalence Ratio.

I. Introduction

Some aircraft, like fighter planes or experimental high-speed aircraft require very high excess thrust to accelerate quickly and to overcome the high drag associated with high speeds. For these airplanes, engine efficiency is not as important as very high thrust. Military aircraft typically employ afterburning turbojets to gain extra thrust for short periods of time. In this educator's guide related topics such as pollution, air density, noise, gas laws, and Newton's laws as related to aircraft engines will be examined.

A jet propulsion mechanism was conceptualized long before the jet plane was ever manufactured. About 300 years ago, Sir Isaac Newton's third law of motion further developed the concept of jet force propulsion by explaining that "for every action there is an equal and opposite reaction." He proposed the idea of a horseless vehicle called the Newton Steam Engine that would use jet propulsion to move. The development of the jet engine made a drastic leap when, in 1928, Sir Frank Whittle offered the first real practical idea which could be effectively used in an aircraft. By 1930, the idea of the jet engine is patented, but it was not until 1937 that the idea took off. Then, in April of 1941, an aircraft called the Gloster E.28 powered by a W1X engine was tested. Only a month later, the same aircraft was flown with a W1 engine. The results provided undeniable proof that Sir Frank Whittle had invented a first-class power unit for aircraft propulsion [1].

The development of the gas turbine engine as an aircraft power plant has been so rapid that it is difficult to appreciate that prior to the 1950s very few people had heard of this method of aircraft propulsion. The possibility of using a reaction jet had interested aircraft designers for a long time, but initially the low speeds of early aircraft and the unsuitability of a piston engine for producing the large high velocity airflow necessary for the jet presented many obstacles [2].

Since suitable heat resisting materials had not then been developed and, in the second place, jet propulsion would have been extremely inefficient at the low speeds of the aircraft of those days. However, today the modern ram jet is very similar to Lorin's conception patented a jet propulsion engine shows in **Fig.1**, [3].

Gas turbine engine designers are attempting to increase thrust to-weight ratio and to widen the thrust range of engine operation, especially for military engines. One major consequence is that the combustor residence time can become shorter than the time required to complete combustion. Therefore, combustion would occur in the turbine passages, which in general has been considered to be undesirable. A thermodynamic analysis for the turbojet engine by the authors [4,5] showed, however, that significant can result from augmented burning in the turbine [6].

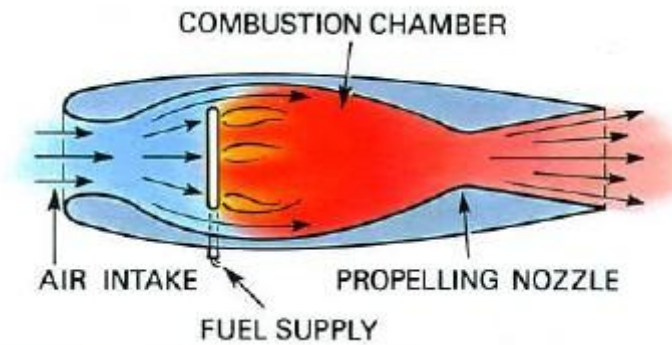

Fig.1 jet propulsion engine [3].

1. Jet Engine Types

There are three main types of jet engines, which are turbojets, turbofan and turboprop. Major components of these engines are similar as they consisted of a compressor, a combustion chamber and a turbine. The acceleration of air to develop thrust are divided into two concepts where the first; large amount of air accelerated at low speed and the second; small amount of air accelerated at high speed. Turbojet and turboprop engines provide propulsive force directly by the accelerated gas in the exhaust. Turbofan engines conversely differ from the other two where thrust is developed by the amount of air bypasses around the basis engine [4].

1.1 Turbojet

The turbojet is the earliest and the simplest form of jet engine. The major component of turbojet consists of a multistage compressor, a combustion chamber and a single or multistage turbine as shown Fig. 2 They produce high specific thrust, and it is the suitable for high subsonic and sonic flight speed.

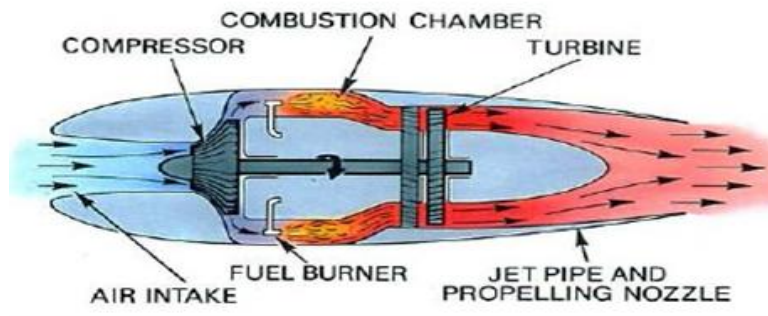

Fig. 2 A Whittle -type turbo-jet engine [7].

1.2 Turbofan

Turbofan as shown in Fig. 3 has a core compressor, combustion chamber and a turbine. In addition, they have a fan in front of the core compressor and second power turbine behind the core turbine. Turbofan engine exhibits good efficiency at high subsonic flow and exhibit lower fuel consumption which is preferred in commercial aircraft transportation.

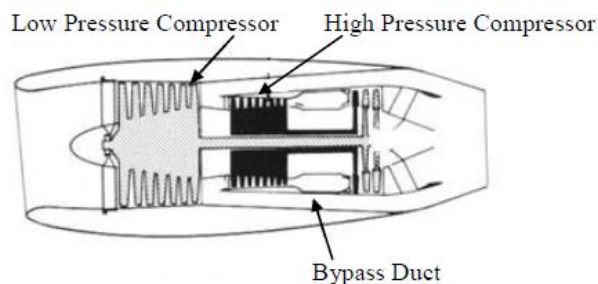

Fig. 3 Schematic illustration of turbofan engine [8].

1.3 Turboprop

Turboprop as shown in Fig. 4 is similar to turbofan, but they have a propeller in front of the compressor. Most of the energy extracted in the turbine is used to drive the propeller. The engine follows the second concept where they were design to accelerate a relatively small amount of air at high speed resulted in high propulsive efficiency. However, the fuel consumptions are relatively lower compared to turbojet at some thrust and flight speed.

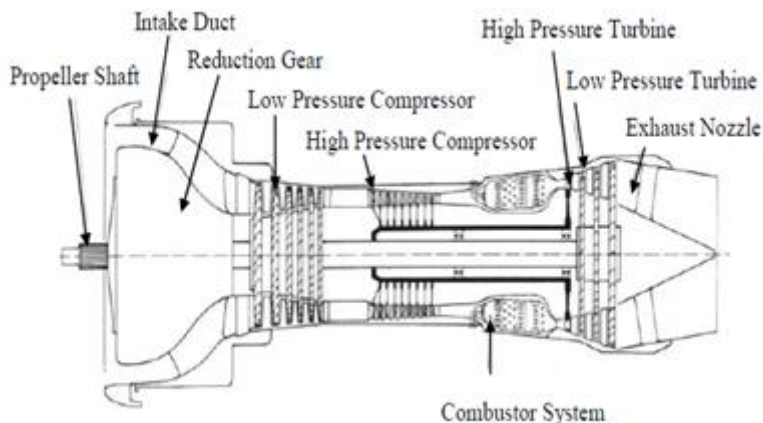

Fig. 4 Schematic illustration of turboprop engine [8].

2. Principle Of Jet Propulsion Engine

2.1 Basic Operations

Jet engine operates at an open cycle called a jet propulsion cycle where it follows Brayton cycles but slightly differs. In an ideal Brayton cycle, the gas from the turbine exit expanded to atmospheric pressure. However, in a jet propulsion cycle, the gas is expanded to a pressure that the power produces by the turbine just sufficient enough to rotate the compressor rotor and other auxiliary equipment's and gives power to the compressor and other auxiliary equipment within the aircraft.

By referring to Fig. 5, air enters the compressor through the inlet diffuser (station 1). As the air enters the diffuser, the air will decelerate and pressure is increased. The pressure will then further increase as it enters the compressor (station 2). The compressed air from the compressor subsequently mixes with fuel in the combustion chamber. At the combustion chamber (station 3), the mixture will burn at a constant pressure. The high pressure and high-temperature gasses will then expand in the turbine (station 4), producing enough power to drive the compressor and other equipment's. The gasses with the "leftover" pressure and temperature will leave the turbine and flow through the nozzle (station 5) where it accelerated to provide thrust (station 6) [9].

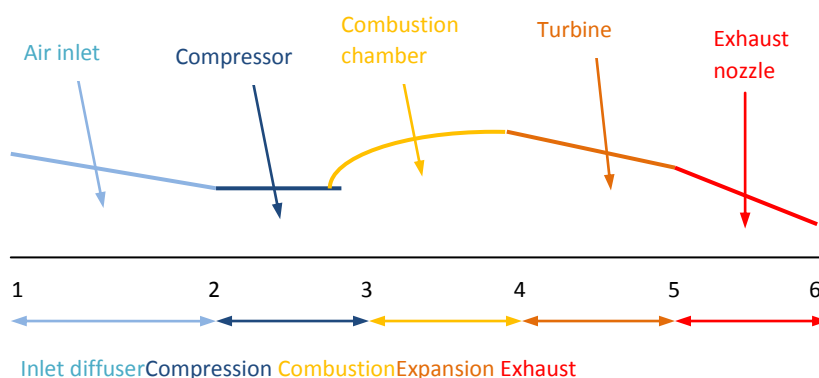

Fig. 5 Schematic diagram of jet-propulsion cycle [9].

2.2 Ideal Jet Propulsion Cycle

Jet propulsion cycle can be analyzed similar to Brayton cycle. The cycle is made up of four internally reversible processes:

- 1-2 Isentropic compression of an ideal gas in a diffuser.
- 2-3 Isentropic compression of an ideal gas in a compressor.
- 3-4 Constant pressure heat addition.
- 4-5 Isentropic expansion of an ideal gas in a turbine.
- 5-6 Isentropic expansion of an ideal gas in a nozzle.

The T-S and P-V diagrams of an ideal propulsive cycle are shown in Fig. 6. These cycles are executed in a steady flow process thus analysis should be made using steady flow assumptions. When changes in potential and kinetic energy are neglected, the energy balanced equation can be expressed as [9].

$$(q_{in} - q_{out}) + (w_{in} - w_{out}) = h_{exit} - h_{inlet} \quad (1)$$

Thus, heat transfer from and to the working fluid are:

$$q_{in} = h_3 - h_2 = cp(T_3 - T_2) \quad (2)$$

$$q_{out} = h_4 - h_1 = cp(T_4 - T_1) \quad (3)$$

Process 2-3 and 4-5 are isentropic and $P_3 = P_4$ and $P_4 = P_1$. Thus,

$$T_3 = T_2 \left(\frac{P_3}{P_2}\right)^{\frac{K-1}{K}} = P_4 \left(\frac{T_3}{T_4}\right)^{\frac{K}{K-1}} \quad (4)$$

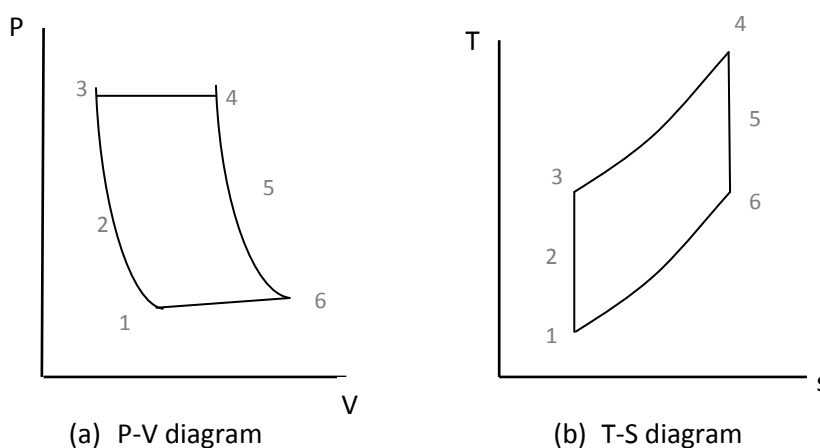

Fig. 6 The ideal jet propulsive cycle [9].

High by-pass or turboj

To understand this statement we may consider the flux of momentum entering and leaving the engine, and a general equation that defines its efficiency.

Flux of momentum entering the engine = $\dot{m}_{air}V$

Flux of momentum leaving the engine = $(\dot{m}_{air} + \dot{m}_f)V_{jet}$

where (\dot{m}_{air}) is the mass flow of air, (V) is the velocity of air entering the engine, (\dot{m}_f) is the mass flow of fuel and (V_{jet}) is the velocity of air leaving the engine. Thus the net thrust, (FN) , that is available in flight is given by the difference between the two momentum fluxes, [10] that is:

$$FN = (\dot{m}_{air} + \dot{m}_f)V_{jet} - \dot{m}_{air}V \quad (5)$$

This equation tells us that for a high net thrust there must be either a high jet velocity, (V_{jet}) , or a large mass flow, (\dot{m}_{air}) . Propulsive efficiency compares the rate of work done on the aircraft to the rate of kinetic energy increase of the flow through the engine. It may be approximated for the typical case when the mass flow (of fuel) is much smaller than that of the air.

$$\eta_P = \frac{2V}{V + V_{jet}} \quad (6)$$

From this second equation we can see that propulsive efficiency (and therefore net engine efficiency) is maximized if the jet velocity, (V_{jet}) , is minimized. Therefore if we wish to maximize efficiency (i.e. low V_{jet}) but maintain thrust (FN) we must maximize the mass flow of air through the engine. Therefore we want high bypass engines for commercial and right air travel.

3. Air Velocity

Incoming air velocity affects the thrust in two different and opposite ways. When the aircraft is static, as when an engine is being run up prior to take-off at the end of a runway, momentum drag is equal to zero, because $V_i = 0$. However, as the aircraft commences to move, the velocity of the air entering the engine also begins to increase because of the speed of the aircraft. Therefore, the difference between V_j and V_i will become less as airspeed, or V_i , increases. On the other hand, as the aircraft gains speed down a runway, the movement of the aircraft relative to the outside air causes air to be rammed into the engine inlet duct. This compression of air in an inlet duct arising from forward motion is called ram pressure or ram effect. The ram effect both increases the air mass flow to the engine and the intake pressure, and consequently, increases the thrust. Fig. 7, shows how the thrust varies with airspeed considering both velocity difference variation and ram effects, [11].

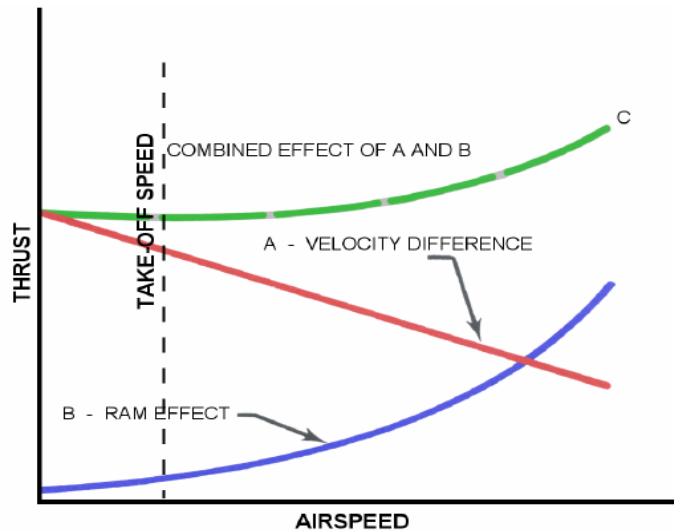

Fig. 7 Jet engine thrust versus airspeed [11].

III. Experimental Setup

1. Turbocharger

Turbochargers, used on gasoline and diesel engines contain both a rotary air compressor and an exhaust gas driven turbine. The turbine is connected to the compressor by a drive shaft. Hot exhaust gasses from the engine drive the turbine wheel which, in turn, drives the compressor that forces pressurized air into the engine. By adding a turbocharger, the output of an internal combustion engine can be increased by 50%, or more.

Turbojet engines operate at high temperatures and produce considerable thrust. A test stand must be constructed in such a manner that it can be fastened to a solid anchor of some method must be used to mount the turbocharger to the test stand. We used a pair of muffler clamps from the truck repair shop. The turbo must be secure so it will not move when running.

2. Compressor

The compressor on the turbocharger serves the same function as the compressor on the turbojet engine. It is used to compress a large amount of air into a small space and increase pressure. The compressor wheel turns at a very high speed; usually between 22,000 and 38,000 rpm. The compressor wheel is usually made from an aluminum alloy. It does not run at a high temperature so aluminum works fine. The temperature of the air will increase 90 to 200 °C. in the compressor. The compressed air exits the compressor into a diffuser. This is usually a casting that increases in area so that the air will be slowed down and the pressure will increase. The compressor end contains the impeller. It is usually an investment casting of aluminum alloy. The blades should all be intact and not bent excessively. The curved portions of the blades near the center are called the inducer vanes and are used to draw air into the compressor where the radial blades accelerate it. The air then passes into the snail shaped housing called the diffuser. Fig. 8, shows the compressor and turbine.

3. Turbine

The turbine is located at the rear of the turbocharger inside a snail housing. The turbine is a radial inflow design. The snail housing is designed to increase the velocity of the inflowing air so that it strikes the turbine blades, at high velocity. The inflowing high speed air strikes the tips of the turbine blades causing the

turbine to rotate at very high speed. The turbine wheel has angled blades near the outlet and is designed to exhaust the hot gases to the rear.

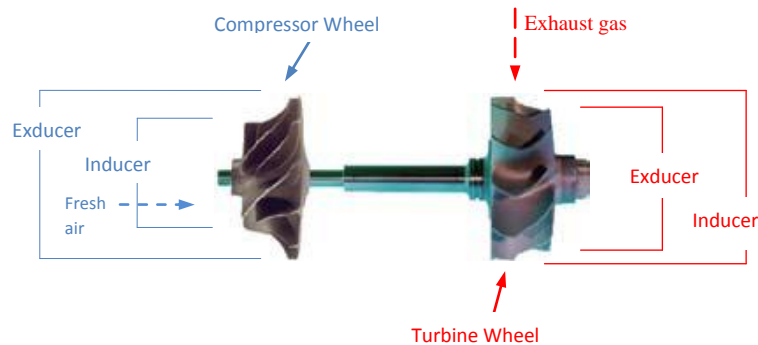

Fig. 8 the compressor and turbine [12].

4. Drive shaft and Bearing

The turbine drives the compressor by means of a drive shaft; usually a very short, small diameter shaft that is friction welded to the turbine wheel and bolted to the compressor. The shaft runs through an aluminum bearing. Most modern turbochargers use hydrodynamic. This is an alloy sleeve bearing with design tolerances that allow a layer of oil between the shaft and the bearing. When the turbocharger is running, the oil supply is under pressure and the shaft rides on a layer of oil and does not touch the alloy bearing. The shaft is suspended on a layer of oil. The thrust bearing on the turbine end rides on a layer of oil and is cooled by oil. The turbine end bearing runs extremely hot, usually about 1,800 deg. F. Large quantities of oil must be circulated to provide adequate cooling.

5. Construction of the Combustion Chamber

The combustion chamber shown in Fig. 9, is the key element of the engine. This is where fuel is mixed with compressed air and burned, causing the air to expand and drive the turbine wheel. A shield called a "combustion liner" is designed to allow some air to mix with the fuel and burn, while the remainder of the air is used to cool the steel parts.

An analogy would be the windproof design of the Zippo lighter. The holes in the combustion liner are adjusted to allow the right amount of air to mix with the fuel so that combustion can occur. If the holes are too large, the incoming pressurized air will blow out the flame. If the holes are too small, there will not be enough oxygen to support combustion. If the holes at the fuel inlet end are too small, the flame will have to travel down the combustion liner until enough oxygen has entered to support combustion. This will cause the combustion to occur in the inlet to the turbine and overheat the turbine. As you can see, the holes in the combustion liner are critical. They can best be determined by trial and error. The holes shown are what we used and are a good starting point. More holes can be drilled as needed. The combustion liner does not extend to the bottom of the combustion chamber. Excess air passes around the liner and continues into the turbine housing. This forms a layer of cool air around the hot gas entering the turbine. We drilled a hole in the turbine housing and inserted a thermocouple.

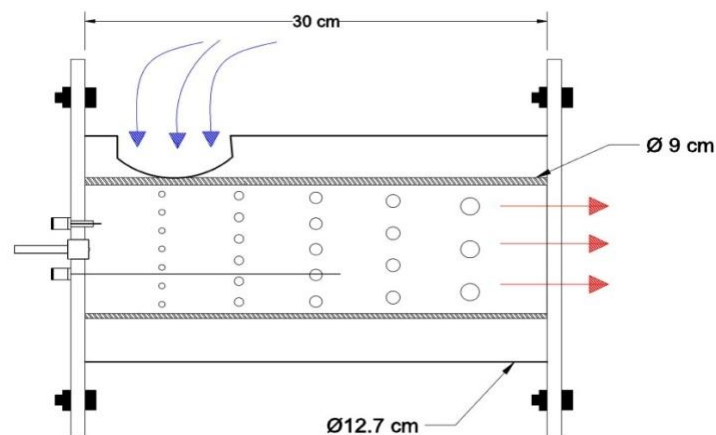

Fig. 9 Combustion chamber.

Fig. 10 &11, shows the configuration of the turbocharger turbojet engine. Notice the three-inch exhaust tube welded to the side of the combustion chamber. This is the air inlet for the combustion chamber. A three-inch rubber elbow is attached to the exhaust tube, and compressor outlet by stainless clamps. These items are available at a local truck supply store. It is recommended that you mount the combustion chamber on the bottom of the engine. This prevents forgotten objects, such as bolts, nuts, etc. from falling into the turbine blades.

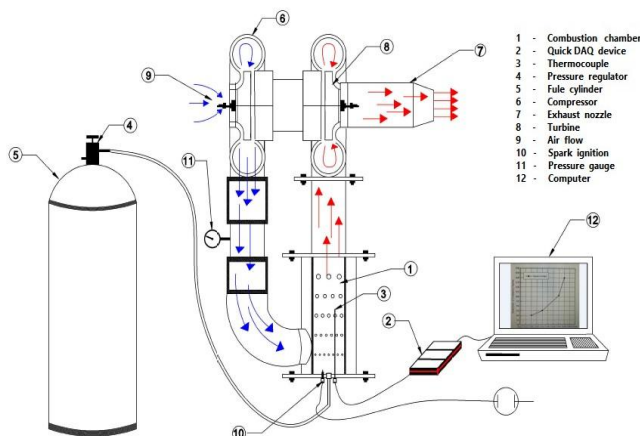

Fig. 10 Schematic diagram of the Turbojet Engine Detail



Fig. 11 Photograph of Turbojet Engine

6. Ignition System

The ignition system consists of a neon transformer, some ignition wire and a spark plug. An old neon transformer from a discarded beer sign works well. We found one that puts out 7,500 volts across the output leads. The transformer, however is center tapped and grounded so you can only use one half of the output. One of the high voltage leads needs to be cut off and wrapped with electrical tape. Wrap it good because this is very high voltage.

Once the engine is running the ignition system can be shut off. The flame in the burner will continue to burn without assistance. The transformer we found had an on-off switch already on it. Which most neon sign transformers have.

7. Exhaust Nozzle

Turbojet engines produce thrust by accelerating mass out the exhaust nozzle. The exhaust outlet is reduced to accelerate the gas molecules. The nozzle is designed to accelerate the hot gasses to a speed just slightly below the speed of sound, When the velocity exceeds the speed of sound the efficiency decreases rapidly. Fig. 12, shows the exhaust duct. It is constructed of six-inch truck exhaust tubing, and exhaust reducer. Both are available at a local truck supply store. You can adjust the dimensions to the turbocharger you are using. Some trial and error is required in determining the exact size of the outlet. Too small an outlet will produce a large amount of back pressure and the temperature of the turbine will increase proportionately.

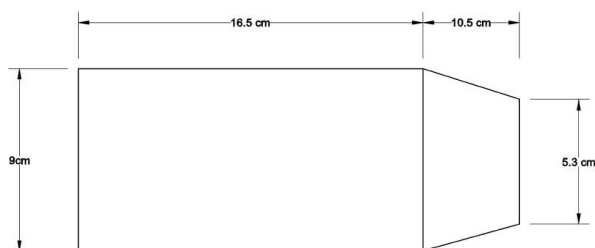

Fig. 12 exhaust nozzle.

IV. Results And Discussion

Fig. 13&14, show the variation of changing the temperature of the combustion chamber and length of the flame with a jet engine speed, noting that the increase in the temperature of the combustion chamber indicate that the chemical reactions are complete, faster with ideal direction of flow of combustion gases through the

blades turbine, thus lead to increase in the speed of the turbine jet engine (turbine and compressor). The complete combustion processes lead to increase in the speed of the turbine and subsequently increasing in the speed of compressor, which in turn increase the amount and speed of the air inside the combustion chamber. In the case of increasing the amount of fuel we get the longer jet flame. As can be observed, the decrease in the amount and speed of air entering the compressor lead to the occurrence of incomplete combustion (a few thermal energy) and thus lead to a decrease in the speed of the combustion products toward the turbine blades resulting in a decrease in the speed of a jet engine.

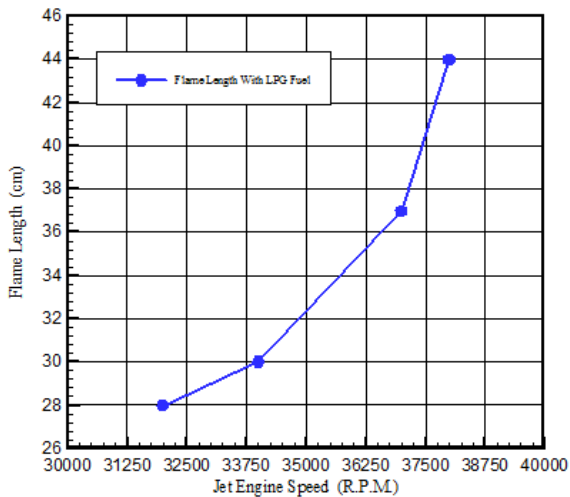

Fig. 13 Jet Engine Speed with Flame Length

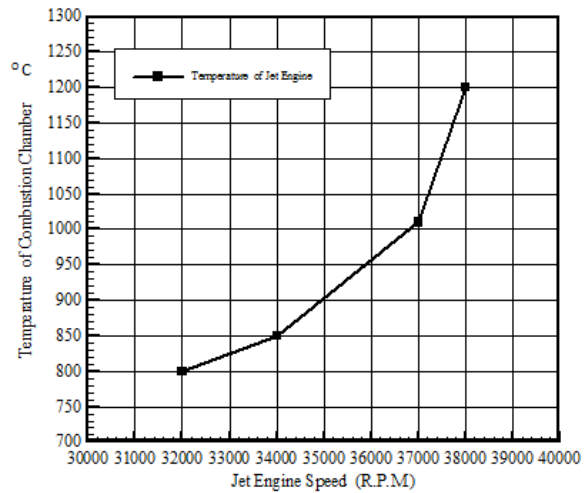

Fig. 14 Jet Engine Speed with Temperature of Combustion

Through Fig. 15&16, It is clear that equivalence ratio (ϕ) have an important role on the jet engine speed and the flame length. It is observed that it is possible to get the maximum speed of jet engine when the equivalence ratio ($\phi = 1$), this is due to the homogeneous combustion of all the reactants (fuel and air). On the other hand, when the mixture is lean or rich, the incomplete combustion lead to change the direction of the reactants in reverse to complete combustion zone, and this process in turn creates a vortices zone lead to a decrease in the flow velocity of the main reactants and consequently reduce the combustion products velocity destined for toward blades turbine which in turn reduces of jet engine speed and thrust force.

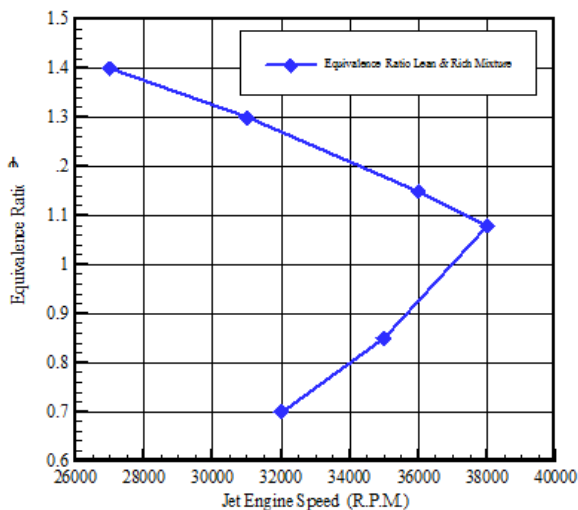

Fig. 15 Jet Engine Speed with Equivalence Ratio

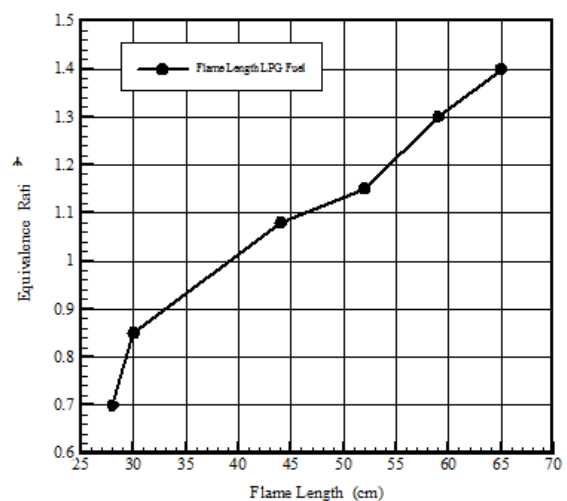

Fig. 16 Flame length with Equivalence Ratio

Fig. 17, shows the three-dimensional relationship between engine speed, combustion temperature and the equivalence ratio. The principle work of jet engines depends on combustion diffusion type. In other words, fuel and air are mixed and burned at the same time. For this reason, the shape design of the combustion chamber and the path of primary and secondary air is essential role to mixing and completeness of the combustion process.

For this reason these properties have been considered at the design and make holes unequally in diagonals along the combustion chamber, so as to take into account mixing integrated ($\phi=1$) at each section of the combustion chamber. Consequently one can get a highest temperature of the burned mixture hence increasing the speed of the combustion products which in turn, works to increase of a jet engine speed. **Fig. 18**, shows difference flame length propagation.

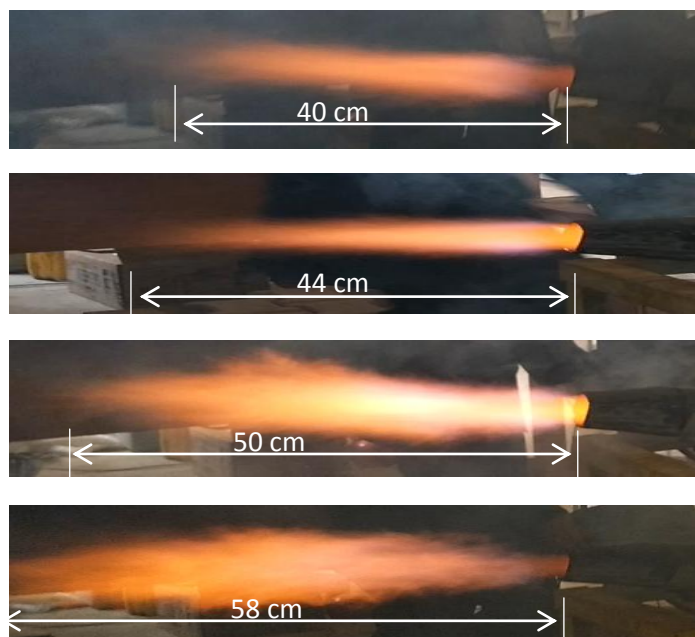
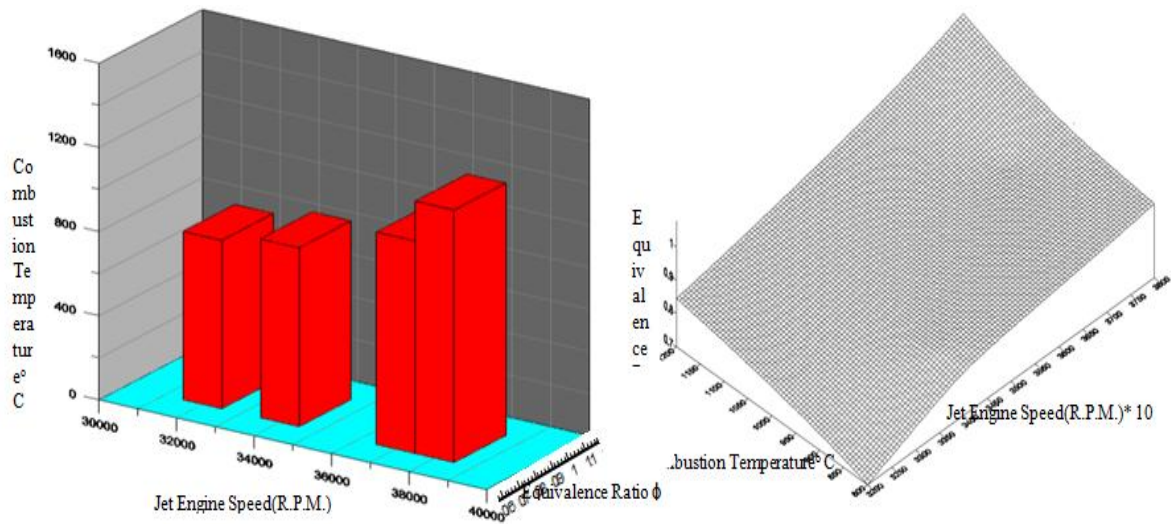

Fig. 18 Photo of difference flame length propagation.

V. Conclusions

1. In our experimental analysis, we explored most of the possible performance, programmatic, design, and technological parameters that effect of jet engine. Our results indicate that rotor inlet, equivalence ratio, and combustion chamber design are a significant variable in most of the relationships.
2. Materials technology continues to drive further advancements in jet-engine performance. There are additional innovations that cannot be included in current designs because of the prohibitive cost. Major improvements will probably result from material development, towards lighter and stronger materials.
3. The equivalent ratio is one of the important parameters that effect of the speed jet engines, and get the maximum speed when the equivalent ratio equal ($\phi=1$).
4. The flame length and impact force increases with increasing equivalent ratio, due to increased fuel ratio in the mixture burning.
5. Design of combustion chamber and the method of entering the primary and secondary air have a essential role in the completed combustion process and the jet engine speed.
6. Increases jet engine speed with increasing the temperature of mixture burning, due to the participation of all the reactants in the combustion process and get the highest energy.
7. Finally, those analysts should also continue collecting data on the speed of jet engine development. Both practices will improve the quality of future cost-estimating tools to high performance of jet engine.

Acknowledgments

The authors would like to thank and acknowledge the staff of workshop in Sulaimani Polytechnic University-Engineering Technical Collage for helping to construct the test rig.

Nomenclature

q_{in}	Heat transfer entering the system, kJ/kg
q_{out}	Heat transfer leaving the system, kJ/kg
w_{in}	Work done on the system, kJ/kg
w_{out}	Work done by the system, kJ/kg
h_{in}	Specific enthalpy entering the system, kJ/kg
h_{out}	Specific enthalpy leaving the system, kJ/kg
C_p	Constant pressurespecific heat, kJ/kgK
T	Temperature, K
h	Specific enthalpy, kJ/kg
P	Pressure, kPa
S	Entropy, kJ/kg
V	Velocity of air entering the engine m/s
V_{jet}	Velocity of air leaving the engine m/s
η_p	Propulsive efficiency
V_i	Initial velocity m/s
ϕ	Equivalence ratio

References

- [1] Borden, Norman Jr. Jet-Engine Fundamentals. Hayden, 1st edition, New York 1967.
- [2] Robert D. and Oscar B., Fundamental of Gas Dynamics, 2nd edition, 2002.
- [3] Rolls-Royce plc ,The Jet Engine, 5th edition, England, 1996.
- [4] Sirignano, W., Delplanque, J., and Liu, F., Selected Challenges in Jet and Rocket Engine Combustion Research, AIAA Paper-97-2701, July 1997.
- [5] Sirignano, W., and Liu, F., performance increases for gas turbine engines through combustion inside the turbine, Journal of Propulsion and Power, Vol. 15, No. 1, 1999, pp. 111–118.
- [6] Liu F. and Sirignano W., Turbojet and Turbofan Engine Performance Increases Through Turbine Burners, journal of propulsion and power, Vol. 17, No. 3, 2001.
- [7] Roger S., Mark S., Lisa D., Tom B., and Carol G., National Aeronautics and Space Administration, USA, 2007.
- [8] Klaus H., Jet Engines: Fundamentals of Theory, Design and Operation, 1st edition, UK, 2010.
- [9] Yunus A. C, Green Energy Systems and Applications, international journal of energy research. Vol.31, issue 12, 2007.
- [10] Nicholas C., Jet Propulsion, A Simple guide to Aerodynamics and Thermodynamic Design and Performance of jet engine (Cambridge University Press), Second edition, 2003.
- [11] Pratt and Whitney, The Aircraft Gas Turbine Engine and Its Operation, United Technologies' P&W Oper. Instr. 200, 1988.
- [12] Honeywell, Turbocharger Guide, Garrett corporation, Volume 4, pp:7, 2004.